

ZW-6 series

HITACHI

Reliable solutions

ZW310



WHEEL LOADER

Model code : ZW310-6

Engine output : 222 kW / 302 hp (ISO14386 net)

Operating weight : 24 140 – 24 590 kg

Bucket ISO heaped : 3.2 – 4.5 m³

ZW310-6. NO COMPROMISE

The ZW310-6 incorporates unique Hitachi technology that has been specially developed for the ZW-6 medium wheel loader range. It offers exceptional levels of performance without compromising on efficiency, thanks to low levels of fuel consumption.

The new model typifies Hitachi's unwavering focus on manufacturing high-quality, reliable and durable products. The ZW310-6 is also extremely versatile for a variety of industry solutions.



6. COMPLETE RELIABILITY



8. BUILT FOR DURABILITY



10. OUTSTANDING VERSATILITY



12. THE HIGHEST QUALITY



14. DRIVEN BY TECHNOLOGY

DEMAND PERFECTION

Designed and built in Japan using pioneering technology, the ZW310-6 delivers exceptional productivity at the lowest possible cost of ownership. Hitachi has developed the medium wheel loader to perfection, with a focus on enhanced environmental awareness, operator comfort and safety.



Powerful performance

Quick power switch increases engine output when required.



Industry-leading safety

360° visibility from the cab.



Easy loading operation

25% improved traction force for easier loading.



Easy to operate

Multifunctional monitor shows information at a glance.



Smooth operation

Ride control minimises machine pitching.





Enhanced design

Excellent rear view thanks to the curved engine hood.



Low emissions

SCR system without DPF reduces NO_x from exhaust gas.



Environmentally friendly

More than 90% of parts are recyclable.



Improved fuel efficiency

Lock-up transmission and Stage IV-compliant engine.



Convenient access

Easy-to-open wide engine covers.



Superior comfort

Spacious cab with several storage compartments.



User-friendly

Effortless control with the optional Joystick Steering System.



“ *Hitachi wheel loaders are the most reliable option* ”

Peter Madsen, Project Director, LNSG

COMPLETE RELIABILITY

Renowned worldwide for manufacturing robust construction machinery, Hitachi has developed its latest range of wheel loaders to deliver a reliable performance with minimal downtime. This means the ZW310-6 is easy to maintain and operates at the highest levels of efficiency on a wide range of job sites.

Quick access

The engine covers open fully for the convenience of technical support. The urea tank is also located for safe and easy access from ground level. These help to ensure routine maintenance is completed quickly to ensure a reliable performance.

Improved fuel efficiency

A new size engine and lock-up transmission have improved the fuel efficiency of the ZW310-6, which reduces running costs.

Easy maintenance

For safer and easier maintenance, the battery disconnect switch is now included as standard. This helps to avoid electrical

accidents and retain battery energy during long-term storage.

Reduced costs

The new Stage IV-compliant engine does not require a diesel particulate filter, which further reduces fuel consumption and maintenance costs.

Reliable performance

The lift arm contributes to the reliable performance of the ZW310-6. Its speed has been improved and it lowers smoothly for increased productivity. It is easy to control using the auto leveller and anti-drift system.



Easy access to the engine compartment.



The battery is easy to maintain.



New engine reduces fuel consumption.



New rear grill protects radiator compartment.



Durable radiators are corrosion resistant.



i Hitachi wheel loaders are tested extensively in job site conditions around the world, in extreme temperatures.



BUILT FOR DURABILITY

The ZW310-6 lives up to Hitachi's market-leading reputation for manufacturing the toughest construction machinery. It has been designed and engineered to withstand challenging working conditions thanks to a variety of features that enhance its durability.



Increased protection

The newly designed rear grill prevents raw material from the job site entering the radiator compartment. This provides greater protection for this durable component.

Additional reinforcement

The optional belly guard protects the machine powertrain and driveshaft from potential damage caused by materials on the ground.



Durable materials

High-quality radiators improve resistance to corrosion and enhance the overall durability of the ZW310-6 wheel loader.

Efficient cooling

The reversible cooling fan, activated manually or automatically every 30 minutes, ensures that the radiator stays clean during operation.

The optional belly guard provides added protection.



“ *The visibility to the front and rear is good, and I have found it to be user-friendly* ”

Tore Bergrud, Technician, Hamar Pukk og Grus

OUTSTANDING VERSATILITY

Smooth, quick and precise, Hitachi wheel loaders are valuable assets for a variety of applications. They have been designed with numerous features to increase efficiency and enhance safety on a wide range of job sites, which underlines their versatility.

Enhanced rear visibility

The muffler and air intake have been moved further away from the cab to improve visibility through the rear window.

Greater traction force

The traction force has improved by 25% compared to the previous model. The result is a more efficient loading operation.

Efficient flexibility

The quick power switch increases engine output when more power is instantly required, or when driving uphill.

Effective control

To ensure a smooth drive on all kinds of terrain, the ride control feature prevents unnecessary pitching via the movement of lift arm cylinders.

High productivity

The simultaneous movement of the bucket and lift arm ensures a smooth digging operation. The bucket is prioritised after unloading so that the wheel loader quickly returns to digging, which helps to increase productivity.



Rear visibility has been enhanced by design modifications.



The ride control feature ensures a smooth performance.



The quick power switch increases power when required.



Urea is injected into the exhaust gas to reduce emissions.



Flow control system ensures smooth movement of the lift arm.

i The final checking and inspection procedure for each Hitachi wheel loader is typical of Hitachi's dedication to manufacturing products of unfailing quality in response to customer needs.



THE HIGHEST QUALITY

Using superior design elements, high-quality components and rigorous testing, Hitachi ensures that its wheel loaders are able to set new industry standards. As a result of this approach, the ZW310-6 is one of the quietest wheel loaders and offers the best all-round visibility in its class.

Reduced emissions

Hitachi has developed a selective catalytic reduction (SCR) system that injects urea into exhaust gas to reduce nitrogen oxide from emissions. This cutting-edge technology not only helps the environment, but also complies with EU Stage IV emission regulations.

Improved comfort

The flow control system ensures the smooth movement of the lift arm when lowering. This means less pitching and a more comfortable experience for the operator.

Excellent visibility

The 360° panoramic view of the spacious cab creates a comfortable working environment, and helps to increase safety

and productivity. The rear-view camera, in combination with the unique two-piece counterweight, also contributes to excellent all-round visibility and safety on the job site.

Low-noise performance

To significantly reduce noise levels in the cab, sound insulation has been improved. As a result of this and the low-noise engine, operators can enjoy a quieter working environment.

User-friendly operation

The optional Joystick Steering System enables operators to reach high levels of productivity with effortless steering, and incorporates a number of useful functions.



The optional Joystick Steering System provides exceptional control.



“ *HCME is constantly focused on enhanced customer satisfaction by developing the latest advanced technology* ”

Vasilis Drougkas, Wheel Loader Product Specialist,
Hitachi Construction Machinery (Europe) NV

DRIVEN BY TECHNOLOGY

Advanced technology is a vital element of the design of the new Hitachi wheel loaders. Continuously developing software, components and innovative features, Hitachi is focused on enhancing customers' experiences of using its construction equipment, and constantly exceeding industry expectations.

Reduced maintenance

A new Stage IV-compliant engine contains a high-volume cooled exhaust gas recirculation (EGR) system, a common rail-type fuel injection system and a diesel oxidation catalyst (DOC) without DPF. This helps to reduce fuel costs and maintenance requirements.

Fewer emissions

The after-treatment device consists of a diesel oxidation catalyst (DOC), urea mixing pipe, SCR system and silencer. This advanced technology is designed to reduce emissions as well as noise levels.

Optimum performance

Hitachi ZW-6 wheel loaders are fitted with a multifunctional LCD colour monitor that shows useful information at a glance, such as fuel and urea levels, oil temperature and power modes. It ensures an optimum performance and easy maintenance. It also includes the display for the easy-to-use rear-view camera, which enhances visibility for a safe operation.

Smaller environmental impact

The optional auto shutdown feature helps to prevent fuel wastage, as well as reduce noise levels, exhaust emissions and NO_x levels of the ZW310-6 wheel loader.

Remote monitoring

Global e-Service allows ZW310-6 owners to monitor their Hitachi machines remotely via Owner's Site (24/7 online access) and ConSite (an automatic monthly report). These help to maximise efficiency, minimise downtime and improve overall performance.



The LCD monitor shows the machine's status and settings.

The urea tank is located for safe and easy access from ground level.

The SCR system reduces emissions and noise levels.



“ We are very happy with the quality and low cost of ownership of the Hitachi wheel loader ”

Phil Meuser-Schaede, owner, Trasswerke Meurin

REDUCING THE TOTAL COST OF OWNERSHIP



SUPPORT CHAIN

Hitachi has created the Support Chain after-sales programme to ensure optimum efficiency, as well as minimal downtime, reduced running costs and high resale values

Global e-Service

Hitachi has developed two remote monitoring systems as part of its Global e-Service online application. Owner's Site and ConSite are an integral part of the wheel loader, which sends operational data daily via GPRS or satellite to www.globaleservice.com. This allows immediate access to the Owner's Site, and the vital information that is required for support on job sites.

Comparing the ratio of operating and non-operating hours helps to enhance efficiency. Effective management of maintenance programmes helps to

maximise availability. Running costs can also be managed by analysing the fuel consumption. The location and movements of each machine are clearly displayed for essential planning.

An automatic service report – ConSite – sends a monthly email summarising the information from Global e-Service for each wheel loader. This includes: daily working hours and fuel consumption data; statistics on the operating mode ratio, plus a comparison for fuel consumption/efficiency, and CO² emissions.

Technical support

Each Hitachi service technician receives full technical training from HCME in Amsterdam. These sessions provide access to the same technical knowledge available within the Hitachi quality assurance departments and design centres. Technicians combine this global expertise with the local language and culture of the customer to provide the highest level of after-sales support.

Extended warranty and service contracts

Every new Hitachi ZW-6 wheel loader is covered by a full manufacturer's



Global e-Service



Technical support



Hitachi Parts

warranty. For extra protection – due to severe working conditions or to minimise equipment repair costs – Hitachi dealers offer a unique extended warranty called HELP (Hitachi Extended Life Program) and comprehensive service contracts. These can help to optimise the performance of each machine, reduce downtime and ensure higher resale values.

Parts

Hitachi offers a wide range and a high availability of parts dispatched from the

53,000 m² HCME European Parts Depot in The Netherlands.

- Hitachi Genuine Parts: allow machines to work for longer, with lower running and maintenance costs.
- Hitachi Select Parts and 2Genuine Parts: especially for older machines, they cost less, are of proven quality and come with the manufacturer's warranty.

- Performance Parts: to cope with highly demanding conditions, they have been engineered for greater durability, better performance or longer life.
- Remanufactured components: offering an economically viable solution, they are the best option when preventative replacements are required.

Whatever the choice, the renowned quality of Hitachi construction machinery is assured.



Compact wheel loaders



ZAXIS excavators



EH dump trucks



“ We develop construction machinery that contributes to the creation of affluent and comfortable societies ”

Yuichi Tsujimoto, HCM President

BUILDING A BETTER FUTURE

Established in 1910, Hitachi, Ltd. was built upon a founding philosophy of making a positive contribution to society through technology. This is still the inspiration behind the Hitachi group's reliable solutions that answer today's challenges and help to create a better world.

Hitachi, Ltd. is now one of the world's largest corporations, with a vast range of innovative products and services. These have been created to challenge convention, improve social infrastructure and contribute to a sustainable society.

Hitachi Construction Machinery Co., Ltd. (HCM) was founded in 1970 as a subsidiary of Hitachi, Ltd. and has become one of the world's largest construction equipment suppliers. A pioneer in producing hydraulic excavators, HCM also manufactures wheel loaders, rigid dump trucks, crawler cranes and special application machines at state-of-the-art facilities across the globe.

Incorporating advanced technology, Hitachi construction machinery has a reputation for the highest quality standards. Suitable for a wide range of industries, it is always

hard at work around the world – helping to create infrastructure for a safe and comfortable way of living, developing natural resources and supporting disaster relief efforts.

Hitachi ZW wheel loaders are renowned for being reliable, durable and versatile – capable of delivering the highest levels of productivity under the most challenging of conditions. They are designed to provide owners with a reduced total cost of ownership, and operators with the ultimate level of comfort and safety.



EX ultra-large excavators

SPECIFICATIONS

ENGINE

Model	CUMMINS QSL9
Type	4-cycle water-cooled, direct injection
Aspiration	Turbocharger and intercooled
Aftertreatment	DOC and SCR system
No. of cylinders	6
Maximum power	
ISO 14396	232 kW (311 hp) at 1 600 min ⁻¹ (rpm)
ISO 9249, net	225 kW (302 hp) at 1 600 min ⁻¹ (rpm)
Maximum torque, gross ...	1 451 Nm at 1 400 min ⁻¹ (rpm)
Bore and stroke	114 mm X 145 mm
Piston displacement	8.9 L
Batteries	2 x 12 V
Air cleaner	Two element dry type with restriction indicator
Emission	Complies with EU stage IV and US EPA Tier 4 Final

Engine output
(kW)

Engine torque
(Nm)

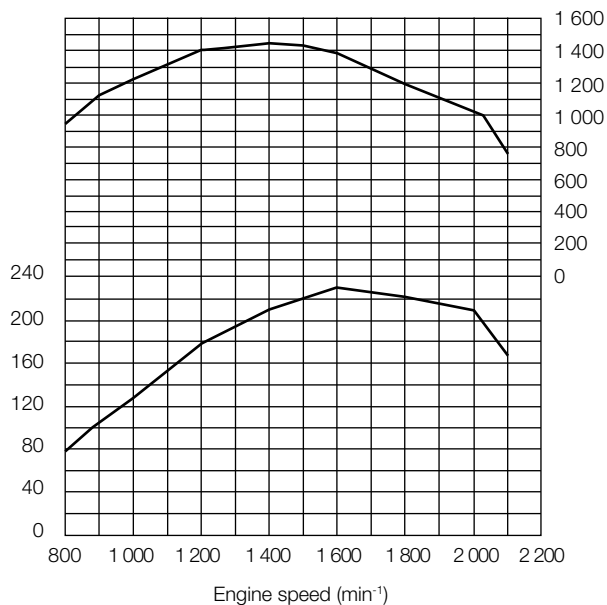

POWER TRAIN

Transmission	Torque converter, countershaft type powershift with computer-controlled automatic shift and manual shift features included
Torque converter	Three element, single stage, single phase with lock-up clutch
Main clutch	Wet hydraulic, multi-disc type
Cooling method	Forced circulation type
Travel speed* Forward / Reverse	
1st	6.6 [6.9] / 6.6 [6.9] km/h
2nd	11.3 (11.3) [11.8 (11.8)] / 11.3 (11.3) [11.8 (11.8)] km/h
3rd	22.2 (22.5) [22.2 (22.5)] / 22.2 (22.5) [22.2 (22.5)] km/h
4th	35.7 (37.0) [35.9 (37.0)] / 35.7 (37.0) [35.9 (37.0)] km/h

*With 26.5R25(L3) tires

(): Data at Lock-up clutch ON

[]: Data at Power mode

AXLE AND FINAL DRIVE

Drive system	Four-wheel drive system
Front & rear axle	Semi-floating
Front	Fixed to the front frame
Rear	Trunnion support
Reduction and differential gear	Two stage reduction with torque proportioning differential (std) / limited slip differential (optional)
Oscillation angle	Total 24° (+12°, -12°)
Final drives	Heavy-duty planetary, mounted inboard

BRAKES

Service brakes	Inboard mounted fully hydraulic 4 wheel wet disc brake. Front & rear independent brake circuit
Parking brake	Spring applied, hydraulically released, located in transmission

STEERING SYSTEM

Type	Articulated frame steering
Steering angle	Each direction 37° ; total 74°
Cylinders	Double-acting piston type
No. x Bore x Stroke	2 x 90 mm x 450 mm

HYDRAULIC SYSTEM

Arm and bucket are controlled by multifunction lever	
Arm controls	Four position valve ; Raise, hold, lower, float
Bucket controls with automatic bucket return-to-dig control	
.....	Three position valve ; Roll back, hold, dump
Main pump (Serve as steering pump)	
.....	Variable piston type
Maximum flow	300 L/min at 2 000 min ⁻¹ (rpm)
Maximum pressure ...	31.4 MPa
Fan pump	
.....	Gear type
Maximum flow	85 L/min at 2 000 min ⁻¹ (rpm)
Maximum pressure ...	16.5 MPa
Hydraulic cylinders	
Type	Double acting type
No. x Bore x Stroke ...	Arm : 2 x 145 mm x 884 mm Bucket : 1 x 180 mm x 525 mm
Filters	Full-flow 15 micron return filter in reservoir
Hydraulic cycle times	
Lift arm raise	5.6 s (5.5 s)
Lift arm lower	4.1 s (4.1 s)
Bucket dump	1.2 s (1.2 s)
Total	10.9 s (10.8 s)

(): Data at Power Mode

SERVICE REFILL CAPACITIES

Fuel tank	375 L
Engine coolant	47 L
Engine oil	24 L
Torque convertor & transmission	51 L
Front axle differential & wheel hubs	48 L
Rear axle differential & wheel hubs	48 L
Hydraulic oil tank	137 L
DEF/AdBlue® tank	35 L

DIMENSIONS & SPECIFICATIONS

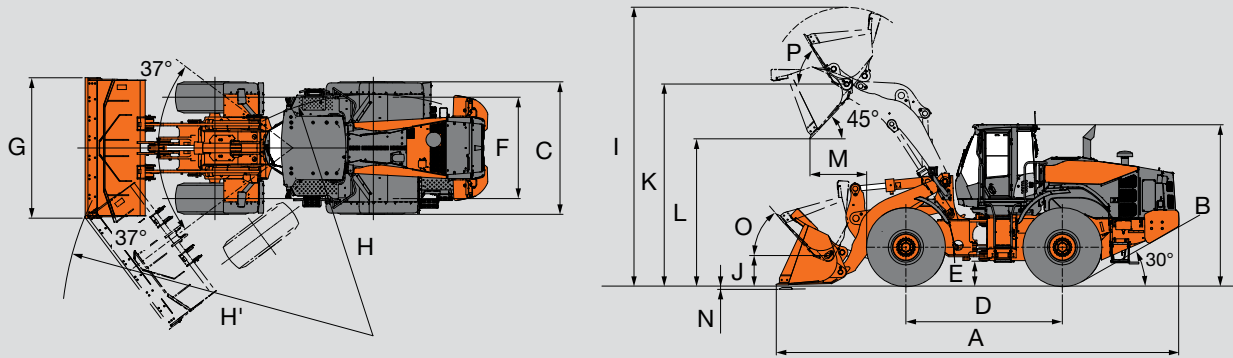

Bucket type			Standard arm						High lift arm	
			General purpose						Rock bucket	Light material
			Round bottom			Flat bottom				Round bottom
			Bolt-on cutting edge	Weld-on adapter & teeth	Bolt-on cutting edge	Bolt-on cutting edge	Weld-on adapter & teeth	Weld-on adapter & teeth	Bolt-on cutting edge	
Bucket capacity	ISO heaped	m ³	4.3	4.1	4.3	4.5	4.1	3.2	4.3	
	ISO struck	m ³	3.7	3.5	3.7	3.9	3.5	2.7	3.7	
A Overall length		mm	9 025	9 185	9 025	9 075	9 185	9 100	9 475	
B Overall height		mm				3 530				
C Width over tires		mm				2 930				
D Wheel base		mm				3 450				
E Ground clearance		mm				505				
F Tread		mm				2 230				
G Bucket width		mm				2 980				
H Turning radius (Centerline of outside tire)		mm				6 270				
H' Loader clearance radius, bucket in carry position		mm	7 250	7 300	7 255	7 265	7 305	7 270	7 440	
I Overall operating height		mm		6 020		6 050	6 020	5 745	6 435	
J Carry height of bucket pin		mm				435				
K Height to bucket hinge pin, fully raised		mm			4 425				4 860	
L Dumping clearance 45 degree, full height		mm	3 090	2 995	3 090	3 060	2 995	3 055	3 530	
M Reach, 45 degree dump, full height		mm	1 305	1 440	1 305	1 355	1 440	1 380	1 370	
N Digging depth (Horizontal digging angle)		deg	120	95	120	115	95	95	120	
O Max. roll back at carry position		deg			45				44	
P Roll back angle at full height		deg				61				
Static tipping load *	Straight	kg	19 170	19 510	19 190	19 000	19 380	19 090	15 910	
	Full 37 degree turn	kg	16 710	17 010	16 740	16 570	16 900	16 640	13 870	
Breakout force		kN	189	203	189	183	203	223	190	
		kgf	19 290	20 710	19 290	18 670	20 710	22 760	19 390	
Operating weight *		kg	24 270	24 140	24 400	24 400	24 260	24 260	24 590	

Note: All dimensions, weight and performance data based on ISO 6746-1:1987, ISO 7131:2009 and ISO 7546:1983

: Static tipping load and operating weight marked with include 26.5R25(L3) tires (No ballast) with lubricants, full fuel tank and operator.

Machine stability and operating weight depend on counterweight, tire size and other attachments.

WEIGHT CHANGE

Option item	Operating weight (kg)	Tipping load (kg)		Overall width (mm) (outside tire)	Overall height (mm)	Overall length (mm)
		Straight	37 degree turn			
Tire	26.5R25(L3) XHA2	± 0	± 0	± 0	± 0	± 0
	26.5R25(L5) XLDD2A	+ 660	+ 500	+ 440	+ 15	+ 35
	26.5R25(L5) XMINED2	+ 1 060	+ 730	+ 650	+ 45	+ 25
Counter weight for road homologation		- 950	- 2 270	- 1 970	± 0	± 0
Belly guard (front & rear)		+ 240	+ 140	+ 130	± 0	± 0

BUCKET SELECTION GUIDE

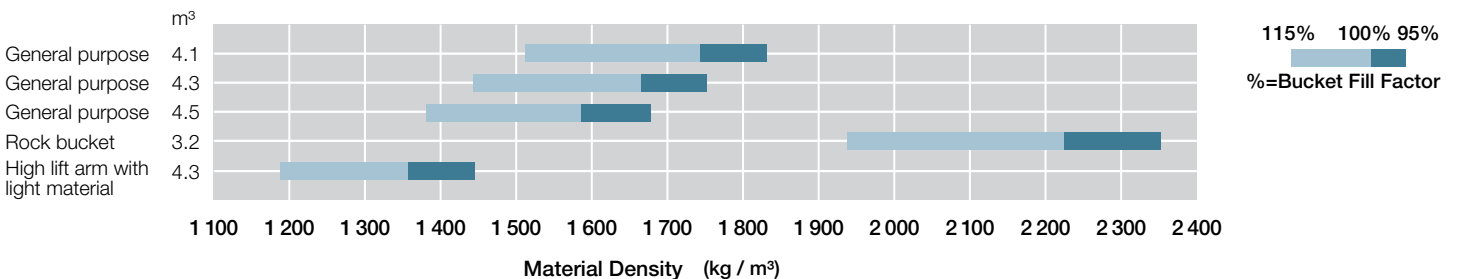

EQUIPMENT

● Standard equipment

○ Optional equipment

OPERATOR'S STATION

Adjustable steering column with POP-UP	●
AM/FM radio with AUX for digital audio player	●
Ashtray, cigar lighter	●
Auto control air conditioner	
with single intake filter	●
with double intake filter	○
Coat hook	●
Front/Rear defroster	●
Glove compartment	●
Rear view camera & monitor	●
Rear view mirrors	
Inside (2)	●
Outside (2)	●
Outside (Heated, 2)	○
Retractable seat belt, 50mm	●
ROPS (ISO3471), FOPS (ISO3449): multi-plane isolation mounted for noise, vibration reduction	●
Rubber floor mat	●
Seat	
Air suspension seat with headrest and heater: fabric, high back, adjustable for damper, inclination of the seat, seat depth, weight-height, fore-aft position, reclining angle, armrest angle, headrest height and angle, lumbar support	●
Air suspension seat (heavy duty) with headrest and heater: fabric, high back, adjustable for damper, inclination of the seat, seat depth, weight-height, fore-aft position, reclining angle, armrest angle, headrest height and angle, lumbar support	○
Steering system	
Wheel steering	●
Joystick steering (with wheel steering)	○
Storage	
Cup holder	●
Digital audio player holder	●
Document holder	●
Hot & cool box	●
Seatback pocket	●
Sun visor	●
Textured steering wheel with spinner knob	●
Tinted safety glass	
Front windshield: laminated	●
Others: tempered	●
Windshield washers for front and rear	●
Windshield wipers for front and rear	●

ELECTRICAL SYSTEM

Backup alarm	●
Batteries	
Standard batteries (120AH-760A)	●
Large capacity batteries (155AH-900A)	○
Battery disconnect switch	●
12V power outlet	○

LIGHTS

Brake & tail lights	●
Clearance lights	●
Headlights	●
Rotating lamp	○
Turn signals with hazard switch	●
Work lights	
Front lights on cab (2)	●
Rear lights on rear grille side cover (2)	●
Additional front lights on cab (2)	○
Rear lights on cab (2)	○

POWER TRAIN

Automatic transmission with load sensing system	●
Axle oil cooler	○
Clutch cut position switch	●
Differential	
TPD (Torque Proportioning Differential, front and rear)	●
LSD (Limited Slip Differential, front and rear)	○
Driving speed limiter (20km/h)	○
DSS (Down Shift Switch)	●
Forward/Reverse lever	●
Forward/Reverse selector switch	●
Lock-up clutch (torque converter)	●
Power mode switch	●
Quick power switch	●
Travel mode selector (Auto1-Auto2)	●

ENGINE

Air intake	
Rain cap	●
Pre-cleaner (Sy-Klone)	○
Pre-cleaner (Turbo II)	○
Air filter double elements	●
Automatic reversible cooling fan with heat sensing	●
Cartridge-type engine oil filter	●
Cartridge-type fuel pre-filter (with water separator function)	●
Cartridge-type fuel main filter	●
Coolant reservoir sight gauge	●
DEF/AdBlue® tank inlet strainer and extension filler	●
DEF/AdBlue® tank with ISO magnet adapter	●
Engine auto shut-down control system	○
Engine oil remote drain	●
Fan guard	●
Radiator (standard fin pitch radiator)	●

Standard and optional equipment may vary by country, so please consult your Hitachi dealer for details.

* Hitachi Construction Machinery cannot be held liable for theft, any system will just minimize the risk of theft.





MONITORING SYSTEM

Gauge: coolant temperature, fuel	●
Indicator lights: clearance lights, control lever lock, fuel level, high beam, parking brake, preheat, turn signals, work lights	●
Indicator on multifunction monitor: air conditioner display, auto shut-down indicator, clock, clutch cut off indicator, DEF alarm indicator, DEF level gauge, dual lift arm auto leveler indicator, ECO indicator, fan reverse indicator, F-N-R/ shift position indicator, forward/reverse selector switch indicator, hold display, hour meter, joystick steering indicator (optional), odometer, power mode indicator, ride control indicator, seat belt indicator, speedometer, tachometer, transmission auto-shifting indicator, transmission oil temperature	●
Warning lights: air filter restriction, brake oil low pressure, communication system error, discharge warning, engine oil low pressure, engine warning, hydraulic oil level, low steering oil pressure, overheat, transmission warning	●

BRAKE SYSTEM

Front & rear independent brake circuit	●
Inboard mounted fully hydraulic 4 wheel wet disc	●
Spring-applied/Hydraulic-released parking brake	●

HYDRAULIC SYSTEM

Bucket auto leveler (Automatic return to dig control)	●
Control lever	
for 2 spools control valve	
Multifunction lever (MF lever)	●
	●
2 levers	○
	○
for 3 spools control valve	
MF lever & AUX lever for 3rd function	○
	○
2 levers & AUX lever for 3rd function	
	
- Inside layout pattern (3rd - bucket - liftarm)	○
- Outside layout pattern (Bucket - liftarm - 3rd)	○
Control lever lock switch	●
Dual lift arm auto leveler	●
Hydraulic filters	●
Lift arm float system	●
Ride control system (OFF-AUTO type)	●

TIRES

26.5R25(L3) XHA2	●
26.5R25(L5) XLDD2A	○
26.5R25(L5) XMINED2	○

MISCELLANEOUS

Articulation lock bar	●
Auto lubrication system	○
Belly guard (Bolt on type)	○
Bucket cylinder guard	○
Counterweight, built-in	●
Counterweight for road homologation	○
Cutting edge protection	○
Drawbar with locking plate	●
Emergency steering	●
Fenders	
for 26.5R25 (Front & full covered rear fenders with mud flaps)	●
Front windshield guard	○
Global e-Service	●
Lift arm	
Standard lift arm	●
High lift arm	○
Lift & tie down hooks	●
On board information controller	●
Pilfer proof	
Battery cover with locking bracket	●
Lockable engine cover	●
Lockable fuel refilling cap	●
Rear license plate bracket	○
Road homologation	
German road homologation kit: rear license plate bracket, reflective sticker, wheel blocks	○
Italian road homologation kit: cab lights, cutting edge protection, link stopper, rear license plate bracket, reflective sticker, rotating lamp	○
Standard tool kit	●
Theft prevention system*	○
Wheel blocks	○

Prior to operating this machine, including satellite communication system, in a country other than a country of its intended use, it may be necessary to make modifications to it so that it complies with the local regulatory standards (including safety standards) and legal requirements of that particular country. Please do not export or operate this machine outside the country of its intended use until such compliance has been confirmed. Please contact your Hitachi dealer in case of questions about compliance.

These specifications are subject to change without notice. Illustrations and photos show the standard models, and may or may not include optional equipment, accessories, and all standard equipment with some differences in color and features. Before use, read and understand the Operator's Manual for proper operation.

