

T9 SERIES WITH PLM INTELLIGENCE™

T9.450 | T9.505 | T9.560 | T9.615 | T9.670



PLM
NEW HOLLAND INTELLIGENCE



Our most precise and powerful 4WD tractor ever.

The new T9 Series with PLM Intelligence™ tractors showcase the best of New Holland's power, comfort, efficiency and versatility. Paired with PLM Intelligence™ connected features integrated into the tractor, the T9 Series tractor is the most advanced, most powerful 4-wheel-drive tractor New Holland has ever offered. Power truly meets precision in the new T9 tractor.





In the T9 Series tractor, operators experience New Holland's latest PLM Intelligence technology with all new in-cab controls that provide control and customisation without complication. The IntelliView™ 12 in-cab monitor offers quick configuration and advanced features such as custom layout options for each individual job and operator, 3-D maps, touchscreen or encoder navigation and seamless integration with PLM 1, PLM 2 and PLM 4 guidance subscriptions. Additionally, with the integrated MYPLMCONNECT™ telematics platform, producers can manage their farm, fleet and data seamlessly.



The PLM Intelligence platform is built to support continuing advancements in precision agriculture, keeping operators on the cutting edge. Through the platform's five-year Advanced Telematics in these models, producers can expect real-time connectivity to their New Holland dealer, improved profitability through remote software updates, diagnostics and data integration, and increased machine uptime. They can also expect the industry's best in guidance, an easier operator interface, and improved decision-making capability from data analytics.

A new level of connectivity and productivity.

Through PLM Intelligence™, New Holland is unlocking a new level of connectivity and remote viewing never before seen in a 4-wheel-drive tractor. That's the inherent advantage of a new T9 Series tractor. In the T9 tractor, unmatched connectivity provides the ability to share information with your preferred providers, perform diagnostics remotely and make data-driven decisions related to your operations—all from any location and all designed to help you successfully manage your farm, fleet and data. You'll accomplish more in a single day, work smarter and more efficiently, and enjoy a superior level of control and management of your entire fleet.



FARM MANAGEMENT

GET MORE DONE EACH DAY. Easily organise your fields, applications and agronomic data to gain better insights.

- ✓ View every field operation, from spring tillage all the way through harvest.
- ✓ Generate satellite maps to help visualise multiple layers of agronomic data to make more informed decisions.
- ✓ Push guidance lines, boundaries and prescriptions to equipment remotely.



FLEET MANAGEMENT

WORK SMARTER BY TRACKING EQUIPMENT. Achieve peak performance by maximizing uptime and efficiency.

- ✓ Receive notifications and view critical operating parameters.
- ✓ Monitor current and historical machine performance.
- ✓ Plan and execute maintenance on connected vehicles.
- ✓ Coordinate your New Holland machines.
- ✓ Remote display viewing enables the farm manager or dealer to view—with the permission from the operator—what is on-screen in the cab of the tractor.



DATA MANAGEMENT

CONNECT AND SECURELY SHARE YOUR FARM DATA.

Gain relevant agronomic insights that connect you to your farm down to the field level.

- ✓ MyPLM Connect helps you seamlessly manage, share and move data—all while ensuring you stay in complete control.
- ✓ Securely share your data and relevant equipment information with trusted partners.
- ✓ Invite your dealer to view relevant farm, field or field operation data for fast, transparent communication.



Remote services to keep you connected. We know you have other commitments in the community or with your family that take you away from your operation. With PLM Intelligence you don't always have to be in the cab of the tractor to see what the operator is seeing. You can remotely view the IntelliView 12 display from wherever you might be. The PLM Intelligence platform connects your farm, fleet and data to help you make well-informed decisions.



Remote Display Viewing

No matter where they are, a farm manager or dealer can easily see exactly what the operator is seeing on the IntelliView 12 display screen in the cab.



Remote Service Support

There's no time for downtime. Now you can work with your local New Holland dealer to remotely diagnose maintenance and service issues to identify parts you need to stay up and running.



Remote Software Updates

Update your vehicles operating software wirelessly to take advantage of new features, functionality, and enhancements.

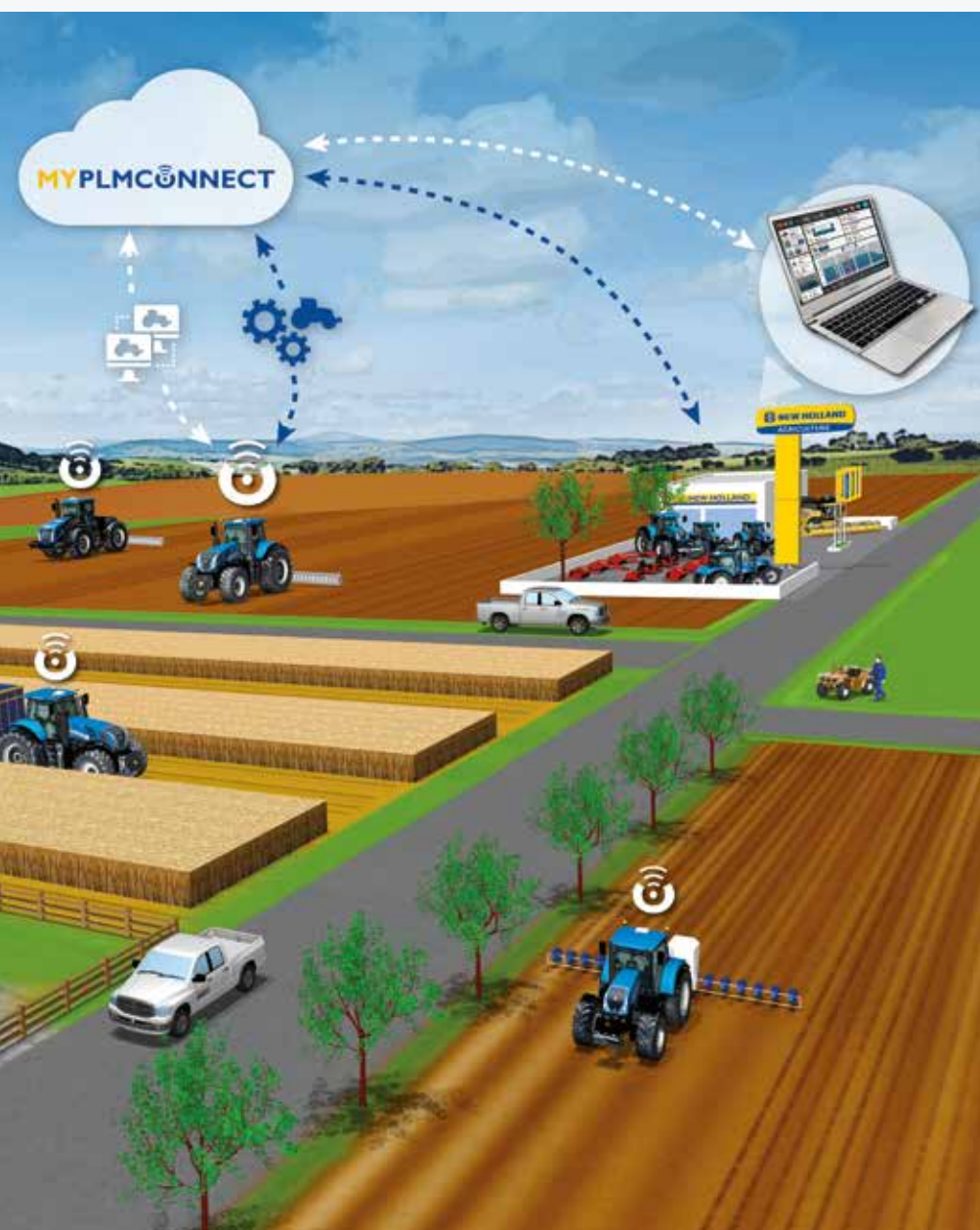

A closer look at what powers your profits.

Take a closer look at the T9 Series with PLM Intelligence advantages that improve your productivity, decrease your cost of ownership and boost your bottom line.

Power, strength and efficiency that's tested and proven

New Holland backs its claims of strength and efficiency with a series of tests conducted by the Nebraska Tractor Test Laboratory (NTTL). These tests found **the complete T9 Series tractor line features best-in-class power, torque, and overall fluid efficiency.** That means your operation benefits from more power to the ground and to implements, better fluid efficiency, and reduced fluid and labour costs.



Ready for precision

Every T9 tractor is factory-ready to farm with precision using New Holland's full range of optional Precision Land Management (PLM™) solutions.

Ultra Command™ Powershift

New Holland's proven powershift transmission saves you fuel and time. The latest improvements reduce the time it takes to shift and shuttle. You can shift from gear 1 to 16 in 20% less time and shift from forward to reverse 38% faster. The result: Ultra Command uses less fuel, decreases operating costs and reduces fatigue.

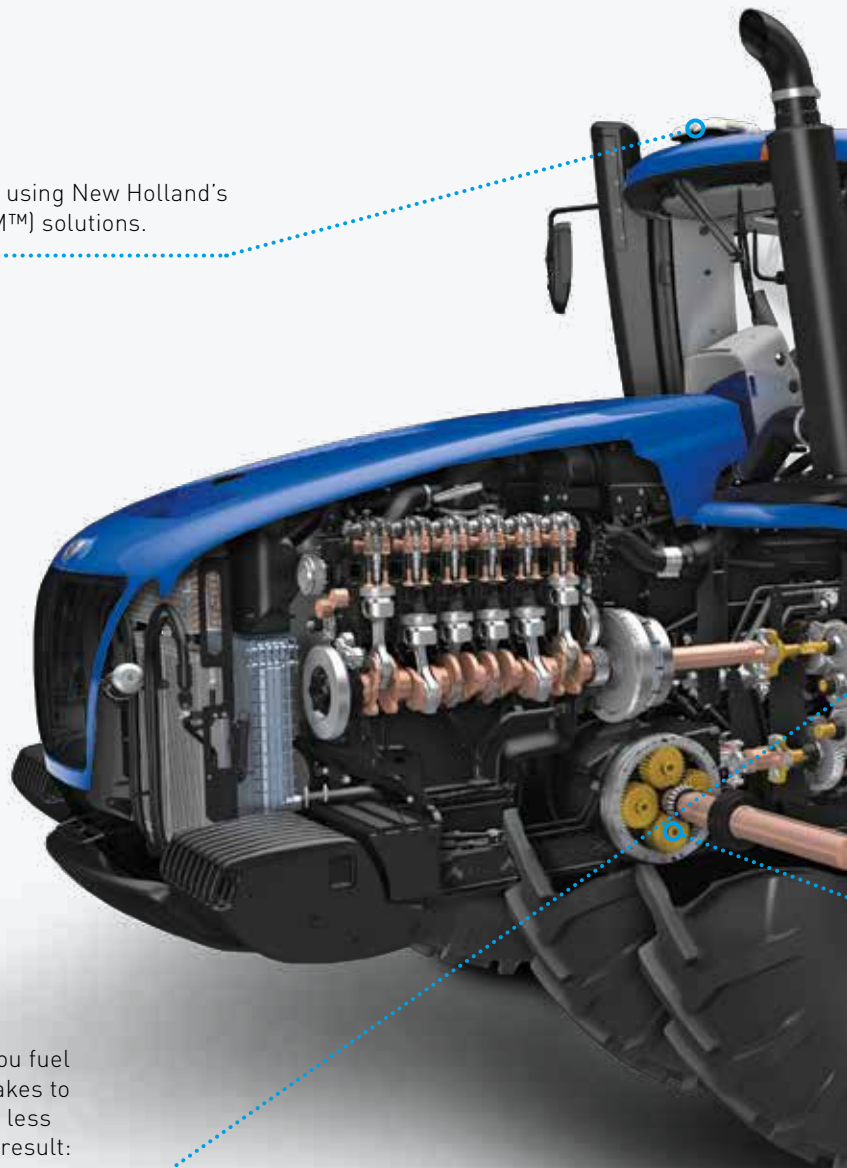

T9 Series with PLM Intelligence™ offering

Models	T9.450	T9.505	T9.560	T9.615	T9.670
Peak Engine Power	446	502	557	613	670
Ultra Command™ Transmission (PowerShift)	●	●	●	●	●
Row Crop Narrow Frame	●	●	●		
High Power Wide Frame				●	●
Heavy Duty Wheeled	●	●	●	●	●
Scraper Heavy-Duty Wheeled				●	●

● Standard



Tri-Point oscillation delivers benefits for you in any application

Whether you're seeding, levelling, cultivating or applying nutrients, New Holland's exceptionally robust articulated Tri-Point chassis ensures precision ground-following and smooth transfer of power to the ground to improve performance and results. The centre section has a large top link that extends from the front frame to the very back of the rear frame transferring dynamic loads more efficiently and maximising your pulling capability, which in turn lowers fuel usage. In addition, this tri-point oscillation ensures well-balanced weight transfer between the front and rear axles so significantly less ballast is required to reduce compaction.

Massive, heavy-duty axles built for the job

Regardless of the model you choose, T9 Series axles are built to stand up to high torque loads. Planetary input gears offer the ultimate in quiet comfort too. The massive 5.5-inch-diameter, heavy-duty axles with 18-bolt hubs carry up to 66,000 pounds of gross vehicle weight and offer superior braking. What this means to you is greater strength, durability, and reliability.

Terralock™ traction management

Terralock is standard equipment and automatically manages four-wheel drive and the engagement of front and rear differential lock. Of equal importance, the system takes care of disengaging 4WD when you apply the brakes and when working at high speeds.

The ultimate in farming comfort.

You'll appreciate the all-new fit and finish and automotive quality of the T9 Series cab. The ergonomic, spacious and practical environment is a must for day-long productivity.

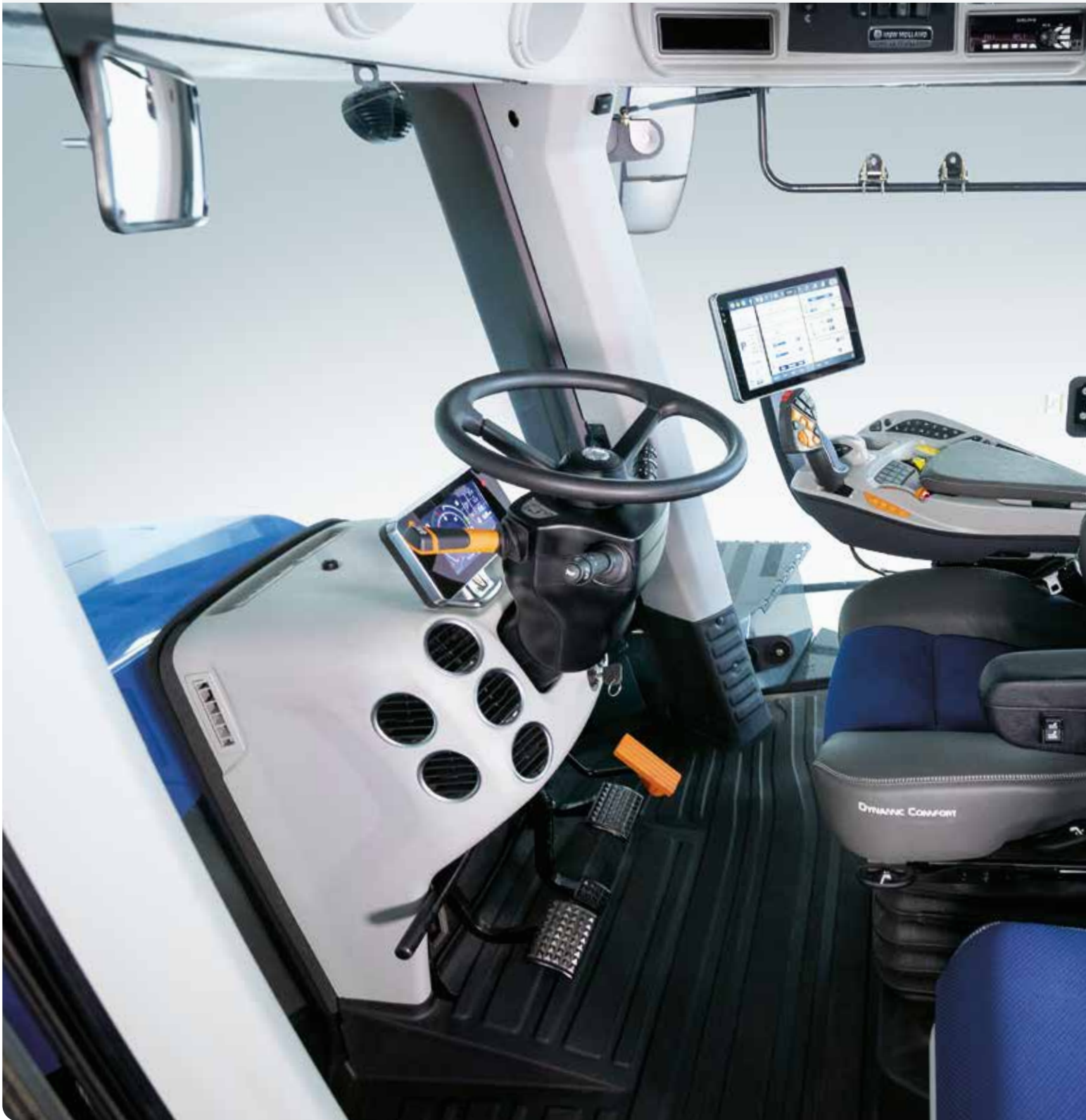

Cab options

New Holland offers you superior comfort and seating with two different cab options.

The **Deluxe Performance cab** features a cloth seat with leather trim, a semi-active suspension and comfort-heating capabilities.

For a premier seating experience consider the **Luxury Performance cab**. Enjoy semi-active suspension and heating capabilities in this seat too, but it's also all-leather and is equipped with a ventilation system that cools and removes moisture to keep operators comfortable and productive when spending extended hours in the tractor.



All-day comfort

The exclusive four-point cab suspension masterfully controls front-to-back, side-to-side, and up-and-down motions to ensure that you are as comfortable after a long day's work as you were before you started.



Settle in and enjoy the ride

The Comfort Ride™ cab suspension is revolutionary. All four corners of the cab are suspended on spring and damper units with a sophisticated anti-sway system to ensure you get a smooth and stable ride. The Comfort Ride suspension is offered on all models.

Your home away from home.

Everywhere you turn inside the T9 Series cab you'll find features—big and small—that make you feel right at home, even on the longest days behind the wheel. Climb aboard and take a look around.



Intuitive climate controls

The entire air-conditioning system has been redesigned with a powerful two-zone cooling system and precisely positioned vents to ensure whole body comfort. All controls have been ergonomically relocated to the SideWinder™ Ultra armrest, making on-the-go adjustments even easier.



Convenient and connected

We put more storage and cupholders in the newly redesigned cab than ever before to ensure maximum comfort. Technology has become part of our lives, too. You'll always be connected with features like 26 total power charging outlets, 12V power ports and exterior camera inputs to keep your devices fully powered.



High-quality audio

The integrated radio allows every operator to play their own MP3 music recording and receive crystal-clear radio signals. Get full access to weather radio channels, too.

Find the right position

The steering wheel now has separate tilt and telescopic adjustment as standard, which makes it even easier for you to select a comfortable working position—invaluable when spending long hours in the field or on the road.



LED power and performance

Lighting up the way for improved night-time productivity and total safety—it's a key priority we achieve by bringing the latest automotive-sector innovations, like LED technology, into the farming world. For hardcore operators who work around the clock, you're covered with our Performance Plus lighting package that provides 360-degree lighting system to turn darkness into light. As an added feature, all of our lighting packages can be configurable through the IntelliView™ 12 display to turn on or off certain light patterns.



SideWinder™ Ultra: the ultimate ergonomic farming experience.

T9 Series tractors offer sophisticated features that are easy and intuitive to access. The SideWinder™ Ultra armrest hosts all key controls, including throttle, transmission and hydraulics. Everything you need to control is intuitively selected. More advanced features can be quickly accessed.



Customisable buttons

Up to 11 buttons can be personalised and configured on the SideWinder™ Ultra armrest. Located in strategic positions around the armrest: one on the multifunction handle, two on both the joystick and main keypad, four on the rear keypad, and one or two on the throttle/transmission keypad (depending on the transmission option selected). These buttons can be configured to suit both the task at hand and the specific preferences of the operator.



Adjustable SideWinder™ Ultra armrest

The SideWinder™ Ultra armrest can be adjusted to suit your specific requirements. Two manual levers adjust both the height and front/back position of the armrest for enhanced ergonomic operation.



- Front or rear linkage control selector
- Thumb wheel for position / draft setting
- CommandGrip™ handle
- STOP button to disengage hydraulics, PTO and linkage
- Fingertip control for up to two remote valves
- Front and rear linkage raise/lower
- Headland Turn Sequencing II (HTS II). Press to record, store and activate automated headland turn
- Forward / reverse shuttle and neutral buttons
- IntelliSteer™ auto-guidance, automated steering engagement
- 1 of 11 configurable buttons
- Fast raise, lower and dig buttons
- Store depth button
- Position or draft selector
- Main tractor functions shortcut buttons
- Terralock™ engagement for automatic management of four-wheel drive and differential lock selection
- Light configuration buttons
- Three stage acceleration and deceleration setting
- 1 of 11 configurable buttons
- Stored Engine Speed Management settings 1 and 2
- Ergonomically positioned hand throttle



Multifunction joystick can be set to operate the front linkage or remote valves

Tractor speed increase / decrease

Forward / reverse shuttle switch

2 configurable buttons

Configuration screen shortcut button

Screen back button

Phone, radio and media controls

Climate controls

Intentional PTO switch, which must be selected to keep the PTO engaged when leaving the operator seat

Engage and disengage the front and rear PTO instantly

Auto PTO will disengage and re-engage both the front and rear PTOs during a headland turn

5 configurable hydraulic valve levers

Thumb wheel encoder

Sliding padded armrest can be adjusted for increased elbow support when using the joystick or CommandGrip™ handle

Front and rear linkage limits settings

4 of 11 configurable buttons

Intelligent monitors for intelligent agriculture.

The all-new IntelliView™ 12 monitor delivers a wide range of machine benefits at your fingertips. A clear evolution from the former IntelliView™ IV, the new “12” model — with its sleek, automotive style “dash” styling, intuitive display and modern design — will become the benchmark of the future.



InfoView™ dash display

The large LCD flat screen display positioned directly in front of the steering wheel is your “at a glance” machine dashboard. It features a host of key operating parameters such as engine rpm, forward speed and selected gear.



Fully customisable

In the IntelliView™ 12 monitor's standard operational layout, the screen is divided into four main areas:

- The top bar allows the operator to access tractor and operation settings.
- The run screens are located on the bottom bar and are customisable and always accessible.
- The main part of the screen is composed of the user-selected run screens, which show key parameters related to the task at hand.
- The left-hand side is another user definable window, which contains primary operating parameters such as fuel rate and slip.



Perfect view

In order to enhance transport safety, a viewing camera has been integrated into the hood. When approaching a traffic junction, this enables you to “see forward” for improved road safety. An additional advantage is that you have a perfect view of front-mounted implements, both while working in the field and when connecting in the yard.



Proven design, modern control.

The full powershift, now even more tough

New Holland has toughened up its already proven Ultra Command™ full powershift transmission. Now with added strength and improved control, it is truly something special. It gives you the benefit of a new control system using the CommandGrip™ handle for fingertip access to “manual” push button shifts and automated Ground Speed Management. A Hi-Lo dual power is fitted to gear 16, allowing you to quickly increase maximum transport speed from 31 to 40 kph.

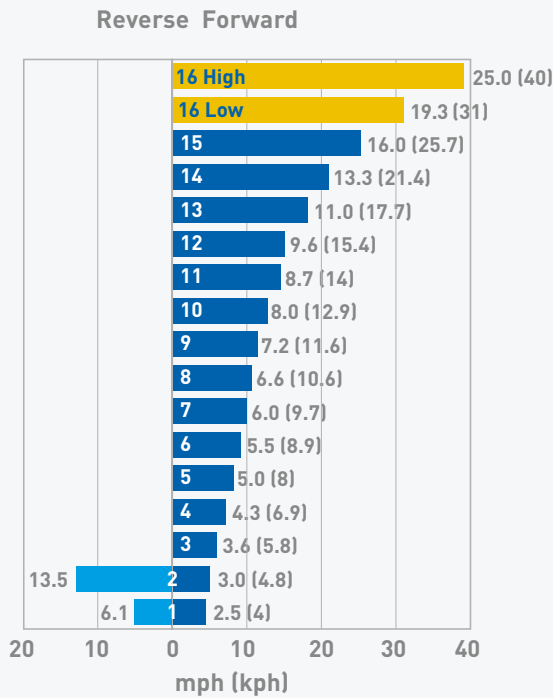

GSM. Intelligent automation.

New Holland Ground Speed Management (GSM) is more than just an automated transmission shift system. Simple to set up and extremely efficient, GSM is a dependable way to reduce operator fatigue and fuel consumption to increase your overall productivity. With CVT-like functionality, it uses a combination of data relating to engine load, forward speed and operator setting, to manage both engine and transmission speeds to optimise performance and economy.

Fixed forward speed? GSM takes care of it.

When load conditions change in the field, GSM automatically maintains a fixed forward speed. Just set your desired working speed and then select the GSM function. The automated system then matches engine and transmission speeds to maintain this fixed forward speed, to deliver the perfect balance between maintaining productivity without compromising economy.



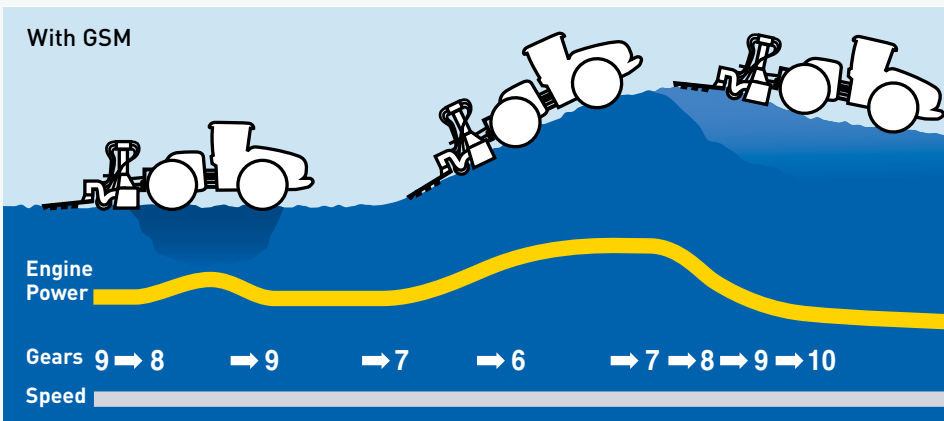

Full command in transport

During road transport, GSM will automatically shift the transmission according to load and throttle settings. With heavy loads, GSM downshifts to assist with engine braking on steep inclines.

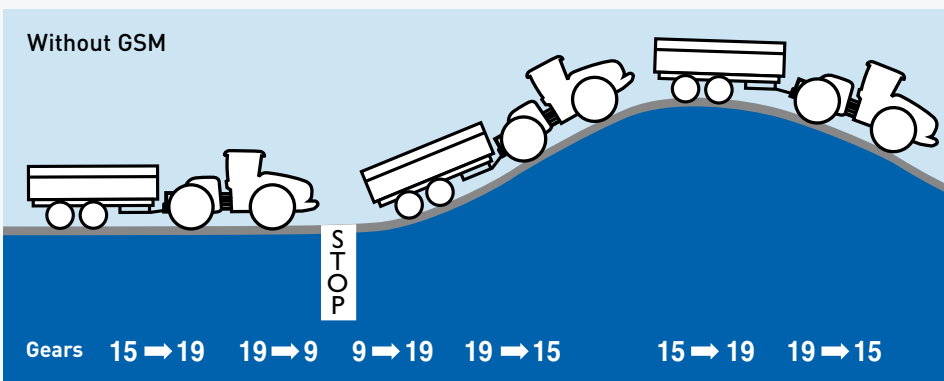





Intelligent tyre options tailored to your operation.

LSW Singles: Low compaction, narrow-width roading

The next generation of tyre solutions comes with Low Side Wall technology — powerful, rugged, balanced, and power hop resistance all wrapped up in a single tyre solution. While increasing the rim diameter but not increasing the tyre diameter, a lower side wall results in a tyre with more stability for heavy pulling and roading applications and high ground area contact — yielding more productive results for your operation.

High Flotation or Row Crop Duals, Triples: Less compaction and fuel usage

Tailor your dual or triple tyres to your operation, whether it's roading, heavy pulling or row crop applications. High-flotation duals feature an IF rating that produces a stronger tyre to carry heavy loads at lower tyre pressure. This results in less compaction and fuel usage. Row crop applications require the proper tyre to decrease compaction and maintain traction throughout the tyre's lifetime, all to improve yields year after year.

Models	T9.450	T9.505	T9.560	T9.615	T9.670
LSW Singles	Available on all models except Scraper				
Row Crop Frame Duals	Available on Row Crop Frame			Available on High HP Frame	
High Flotation Duals	Available on all models				
Triples	Available on all models				
Rated HP	400	450	500	535	600
Transmission	UltraCommand™				
Cab Suspension	Standard on all models				





Low Side Wall technology: Solutions for high flotation, heavy pulling, and roading applications all in a single tyre.

**NARROW ROADING
HIGH FLOTATION
HEAVY PULLING
MEETING NEW DEMANDS**

New Holland T9 Series tractors can now be equipped with Low Side Wall (LSW) tyres to meet the new demands of producers looking for high flotation, heavy pulling, and a narrow overall package for roading applications. LSW tyres feature the ability to maintain high load ratings at 40% lower inflation psi values, opening new productivity value to a single tyre combination. The larger rim diameter — without increasing the overall LSW tyre diameter — results in a more stable tyre for the toughest applications.



When equipped with LSW1250/35R46 singles, the overall width measures about 150 inches or 12.5 feet. This narrow roading width, in combination with a light footprint, provides a middle ground.

Low Side Wall tyres design features a larger rim diameter without increasing the overall tyre diameter, providing more stability for heavy pull and roading applications.

As the aspect ratio of a tyre increases so does the chance for bouncing during roading and power-hop in in-field heavy pull applications. LSW tyres eliminate those chances with a lower aspect ratio.

With LSW singles, total psi on the ground is comparable to high-flotation duals on tractors with similar gross vehicle weight — but yields a nearly 20% reduction in overall tyre width.

The Dual and Triple threat: Tyre combinations to meet your row crop or high-flotation needs.

**IN-ROW APPLICATIONS
HIGH FLOTATION
HEAVY PULLING
MATCH TO YOUR NEEDS**

New Holland T9 Series tractors utilise the Row Crop frame on models up to the T9.560. When used in combination with VF Row Crop tyres, they maintain load carrying capacities at lower air pressure ratings — producing less compaction, less fuel consumption to promote bottom line returns. High flotation duals can also be equipped with this technology, further improving fuel consumption in heavy-pull applications. Triples distribute the overall weight of the T9 Series tractor over even more area, decreasing compaction for your specific application.



Row Crop Frame and Row Crop Duals are perfectly matched for row-crop applications

Spring tillage, planting, post emergence side-dressing, grain carting, roading, and fall primary tillage—there is no application that the T9 Series tractor can't handle.

High Power Wide Frame and High Flotation Duals provide the power to where it's needed

Heavy-pull applications call for the High Power Frame matched with high-flotation tyres. Tyre designs featuring improved traction capabilities are made for these kinds of applications.



Grain cart applications with VF dual tyres (Row Crop Frame shown) allow for high-speed, low-pressure inflation, which lessens soil compaction while boosting fuel economy. Through less compaction, the T9 Series tractor improves your harvest and yields the following year.

Rugged design meets perfect balance.



Up to 20,000-pound hitch lift capacity

All models can be equipped with a CAT IV-N quick-hitch rear linkage, convertible to CAT III on standard frame models. Lift capacity rises to more than 20,000 pounds on standard frame tractors, in line with the high power output of the T9.560. A 20-spline 1000-rpm speed PTO option is also available.

The right balance

It takes experience to ballast an articulated tractor correctly. Get the weights wrong, and performance, fuel use, soil compaction and productivity can all suffer. At New Holland we have established ballast guidelines that make it easier to optimise ballast, with purpose-developed weight packs that can be tailored to match your needs.



Drawbar options to suit your needs

A heat-treated two-position agricultural solid bar is fitted to standard frame models. A heavy-duty Class 5 is offered on wide-chassis models. Max permissible tongue weight can reach up to 15,000 pounds on Ag models and 20,000 pounds on scraper models, dependent on drawbar choice.



Impressive hydraulic flow to handle the largest implements.

Up to 427 lts per minute

T9 Series tractors are made available standard with MegaFlow hydraulic pumps, delivering a total flow to all hydraulic remotes of 427 lpm. For extremely high hydraulic demands like seeding and planting, choose the MegaFlow™ II option. A large coupler is available for applications that demand unrestricted oil flow.



Save time and effort with Custom Headland Management

New Holland has refined and developed Custom Headland Management for easier setup and use. For complex applications, including operating the very widest tillage equipment, Custom Headland Management truly does reduce fatigue and help remove the repetition from your day so you can concentrate on what's really important. Use Custom Headland Management to manage some operations but leave others to manual control — the choice is up to you. Set up is simply a case of recording the desired operations at the headland. These actions are then repeated, automatically, by pressing the dedicated button on the CommandGrip™ handle.

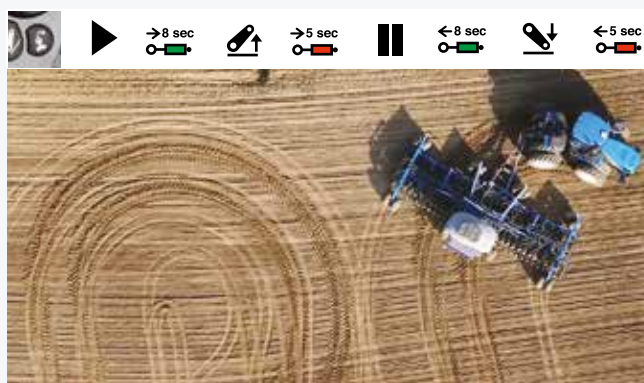

Up to eight electronic remotes

T9 Series remote valves are easy to identify with colour-coded couplers and levers. You control all eight remotes without moving away from the SideWinder™ Ultra armrest, allowing you to identify and work each remote with exact precision. Four remote levers are on the armrest and two valves are controlled either using the two additional paddles located to the right of the IntelliView™ monitor, by using the CommandGrip™ handle or by using the electronic joystick. You can set flow, timing and detent settings to precisely match the job. Each valve can also be programmed with Custom Headland Management.



Hydraulic remote valve management

It is now even easier to control hydraulic functions, as each hydraulic remote valve is indicated by a coloured LED paddle. The remote paddle position on the SideWinder™ Ultra armrest is completely configurable, so operators can choose which paddle operates which hydraulic remote. This makes it easier to customise usage based on application and operator preference.

Quick and simple flow control setting

The IntelliView™ 12 touchscreen monitor makes setting flow rates to individual valves simple. Scroll through the menus and select valve control. Choose the outlet you wish to adjust, and drag the slider with your finger to the desired setting or use the front armrest encoder wheel. Job done.

MODELS

T9.450
WheeledT9.505
WheeledT9.560
WheeledT9.615
WheeledT9.670
Wheeled

Engine*		FPT Cursor 13	FPT Cursor 13	FPT Cursor 13	FPT Cursor 13 Two-stage Turbo	FPT Cursor 13 Two-stage Turbo
No. of cyl. / Aspiration / Valves		6/WT/4	6/WT/4	6/WT/4	6/WT/4	6/WT/4
Cylinders / Valves / Displacement	cu. in. (L)	6/24/787 (12.9)	6/24/787 (12.9)	6/24/787 (12.9)	6/24/787 (12.9)	6/24/787 (12.9)
Approved biodiesel blend**		B7	B7	B7	B7	B7
Max. EPM horsepower @ 1,900 rpm	CV hp (kW)	446 (332)	502 (374)	557 (415)	613 (457)	670 (499)
Rated horsepower @ rated RPM per SAE	CV hp (kW) @ 2,100 rpm	405 (302)	457 (340) @ 2,100 rpm	507 (378) @ 2,100 rpm	542 (404) @ 2,100 rpm	600 (447) @ 2,100 rpm
PTO power @ rated 1,811 engine rpm	CV hp (kW)	355 (264)	405 (302)	435 (324)	473 (352)	473 (352)
Max. torque - ISO TR14396	(Nm)	1899 @ 1400	2136 @ 1400	2374 @ 1400	2540 @ 1400	2832 @ 1400
Torque rise	%	40	40	40	40	40
Viscous coupled cooling fan		●	●	●	—	—
Hydraulically driven cooling fan		—	—	—	●	●
Engine Exhaust brake		●	●	●	●	●
Diesel capacity (Wheeled)	(L)	871	871	1230	1816	1816
Service interval	hours	600	600	600	600	600
Transmission						
Ultra Command™ transmission		○	○	○	○	○
IntelliShift™ System		●	●	●	●	●
Ground Speed Management (GSM)		●	●	●	●	●
Number of gears	F x R	16 x 2	16 x 2	16 x 2	16 x 2	16 x 2
Min. speed / Max. speed (Wheeled)	mph (kph)	2.5/25 (4/40)	2.5/25 (4/40)	2.5/25 (4/40)	2.5/25 (4/40)	2.5/25 (4/40)
Configurations						
Frame width Wheeled	in. (mm)	36.5 (927)	36.5 (927)	36.5 (927)	44 (1118)	44 (1118)
Electrical						
Alternator/Battery/Electrical Cutoff Switch		200 amp/2 x 1000CCA/Yes	200 amp/2 x 1000CCA/Yes	200 amp/2 x 1000CCA/Yes	240 amp/2 x 1000CCA/Yes	240 amp/2 x 1000CCA/Yes
Axles						
4WD front axle		●	●	●	●	●
Articulation angle Wheeled	degrees	42	42	42	42	42
Turning radius	(mm)	4900	4900	4900	5700	5700
Front & Rear Diff-lock		●	●	●	●	●
Hydraulics						
Closed Centre Load Sensing (CCLS)		●	●	●	●	●
High Flow pump	(LPM)	216	216	216	216	216
MegaFlow™ II pump flow Standard / High flow (Total flow available across all remotes)	(LPM)	428	428	428	428	428
Electronic Draft Control (EDC)		●	●	●	●	●
Remote valves						
Type		Electro hydraulic	Electro hydraulic	Electro hydraulic	Electro hydraulic	Electro hydraulic
Max. no. rear valves		8	8	8	8	8
Std. no. rear valves		6	6	6	6	6
Joystick control		○	○	○	○	○
Rear linkage		○	○	○	○	○
Rear linkage category		IV-N	IV-N	IV-N	IV-N	IV-N
Max. lift capacity through the range (610 mm behind ball ends)	(kg)	21,903	21,903	21,903	19,621	19,621
Rear PTO - Std on AG only						
Auto Soft Start		●	●	●	●	●
Engine speed at 1000 rpm	engine rpm	1800	1800	1800	1800	1800

● Standard ○ Optional — Not Available *Developed by FPT Industrial

**Biodiesel blend must fully comply with the latest fuel specification EN14214:2009 and operation is in accordance with operator manual guidelines

MODELS

T9.450
WheeledT9.505
WheeledT9.560
WheeledT9.615
WheeledT9.670
Wheeled

		T9.450 Wheeled	T9.505 Wheeled	T9.560 Wheeled	T9.615 Wheeled	T9.670 Wheeled
Brakes						
Electronic park brake		●	●	●	●	●
Hydraulic trailer brakes		○	○	○	○	○
Cab						
Volume (size) / Glass 132 cu ft/88.1 sq. ft.		●	●	●	●	●
360° 4 pillar cab with FOPS - OECD Code 10 Level 1		●	●	●	●	●
Cab category level - EN 15695		2	2	2	2	2
High visibility RHS window		●	●	●	●	●
HID lighting pack		○	○	○	○	○
SideWinder™ Ultra armrest		●	●	●	●	●
CommandGrip™ handle		●	●	●	●	●
Manual adjustment of SideWinder™ Ultra armrest		●	●	●	●	●
Air conditioning		●	●	●	●	●
Automatic climate control		●	●	●	●	●
Air recirculation filters		●	●	●	●	●
Bluetooth radio		●	●	●	●	●
Telescopic mirrors		○	○	○	○	○
Electronic remotely adjustable mirrors		●	●	●	●	●
Comfort Ride™ cab suspension		●	●	●	●	●
Custom Headland Management (HST II)		●	●	●	●	●
InfoView™ Display Monitor		●	●	●	●	●
IntelliView™ 12 color monitor with ISO 11783 connector		●	●	●	●	●
IntelliSteer™ guidance ready		●	●	●	●	●
PLM® Connect Telematics (Telematics components standard with FT advanced subscription)		●	●	●	●	●
Optimum cab noise level EC 77/311	dB(A)	74	74	74	74	74
Factory fit rotating beacons		●	●	●	●	●
Weights						
Wheel Models - Base Shipping Weight	lbs. (kg)	39,820 (18,062)	39,820 (18,062)	39,820 (18,062)	45,325 (20,559)	49,330 (22,375)
Wheel Models - Max Gross Vehicle Weight	lbs. (kg)	49,500 (22,453)	49,500 (22,453)	49,500 (22,453)	56,000 (25,401)	66,000 (29,937)

● Standard ○ Optional — Not Available *Developed by FPT Industrial

**Biodiesel blend must fully comply with the latest fuel specification EN14214:2009 and operation is in accordance with operator manual guidelines

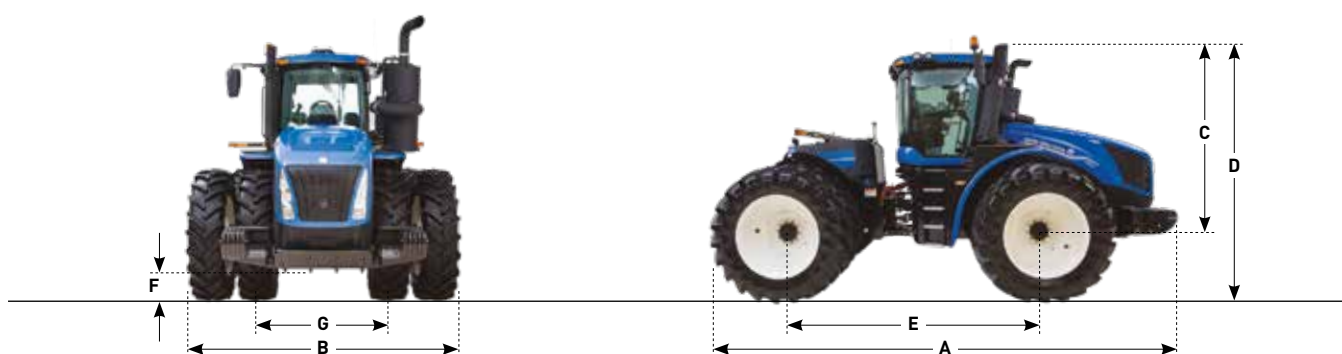

MODELS

T9.450 - 560

T9.615 - 670

Dimensions		T9.450 - 560	T9.615 - 670
With rear tyre size		710/70R42 - Duals	710/70R42 - Duals
A Overall length including front weight pack and rear drawbar	(mm)	7393	7615
B Min. width across bar axle	(mm)	3048	3048
C Height at centre of rear axle to top of cab	(mm)	2794	2903
D Overall height	(mm)	3843	3963
E Wheelbase	(mm)	3759	3911
F Ground clearance (depends on drawbar)	(mm)	443	447
G Width at fenders	(mm)	2549	2549

New Holland.
A real specialist in your agricultural business.

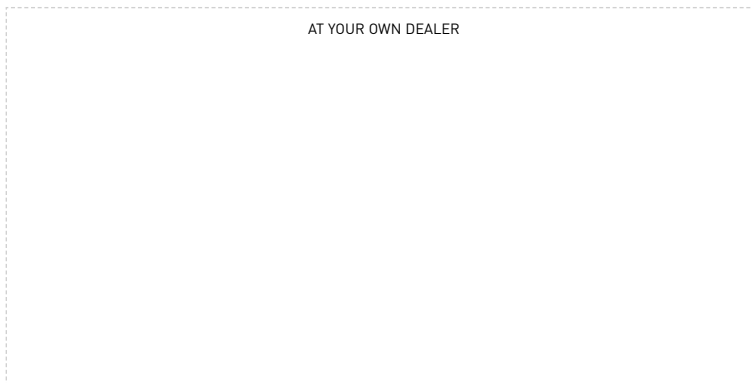

Visit our website: www.newholland.com
Send us an e-mail: international@newholland.com



The data indicated in this folder are approximate. The models described here can be subjected to modifications without any notice by the manufacturer. The drawings and photos may refer to equipment that is either optional or intended for other countries. Please apply to our Sales Network for any further information. Published by New Holland Brand Communications. creative-farm.it - 04/21 - AMEA21102

New Holland prefers **AMBRA** lubricants