



Forage harvesters

JAGUAR

980 970 960 950 940 930

CLAAS



Follow your gut instinct. JAGUAR – the forager.

When you need sophisticated engineering, dependable performance and outstanding results. When your head and your gut instinct are telling you the same thing. Then it's time for the new JAGUAR. With its unique overall concept, a new header drive and a wide range of corncracker rollers including patented SHREDLAGE technology, it will help you safely bring in your harvest with up to 884 hp.





Innovations	6	Discharge	56
		Crop accelerator,	
		discharge spout	58
Technology in detail	8	Discharge spout, AUTO FILL	60
		QUANTIMETER dry matter sensor,	
Comfort cab	10	silage additive systems	62
CEBIS on-board			
information system	14		
		Front attachments	64
CLAAS POWER SYSTEMS	16	PICK UP	66
Engines	18	DIRECT DISC	68
Cooling	20	ORBIS SD, ORBIS	70
CRUISE PILOT	22	RU 450	72
DYNAMIC POWER	24	CORIO	74
Running gear	26		
Hydraulics, electrics	30	Electronics expertise	
		TELEMATICS	76
Chopping system	32	Modular data management	78
Drive	34	Guidance systems	80
Crop flow, intake	36		
Front attachment drive	38	PREMIUM LINE	82
Intake	40	ORBIS	84
Hydraulic precompression	44		
V-MAX chopping cylinder	46	Maintenance	86
Chopping assembly	48	CLAAS Service & Parts	88
Corncracker expertise	50	Equipment package	90
Corncracker overview	54		
		Technical data	91

To meet your requirements.

At CLAAS we work every day to make the world of agriculture a little better. We do this with up-to-date machines, with real engineering skill and above all with mud on our boots. Once our machines have finished their work, another field is ready to be cultivated. And the cycle from drilling to harvesting begins once again.

All our efforts are geared to ensuring that people are able to return from the field at the end of the day with the satisfaction that they have done a good job. And every day we develop new ideas to keep things that way. Some outstanding examples can be found in the new JAGUAR. In this way, we ensure that it continues to be the most popular forage harvester in the world.



Page 46

NEW: V-MAX chopping cylinder.
Symmetrical knife arrangement for use with corncracker when equipped with half the number of knives.



Page 44

NEW: Hydraulic precompression.
For consistently good chop quality through active precompression of the crop.

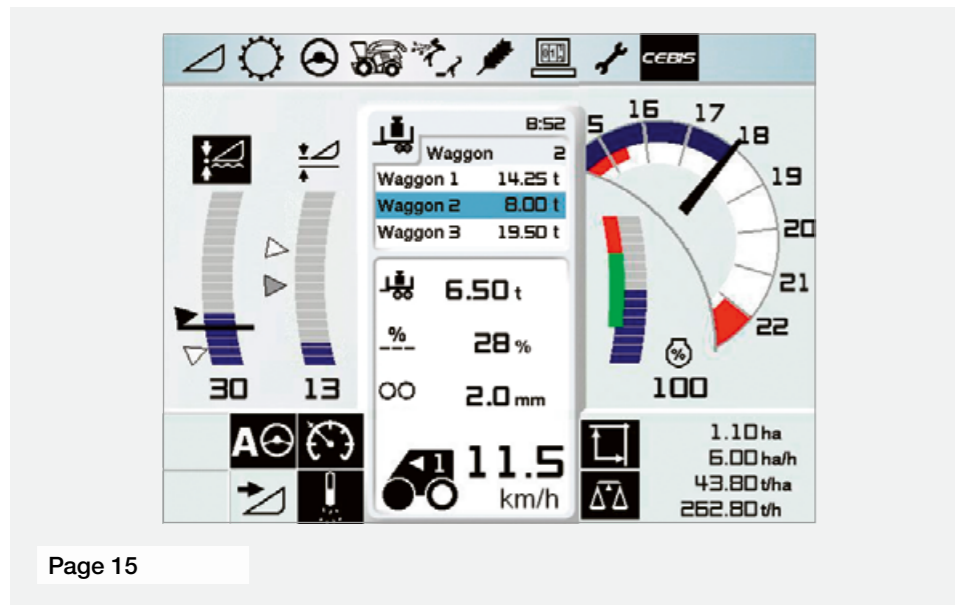

Page 15

NEW: Programmed payload detection for forage trailers.
Load status of selected trailer is displayed in CEBIS.



Page 66

NEW: PICK UP 300 / 380.
Powerful crop flow with high level of protection for the drives and excellent ground-contour following through suspended frame.



Page 68

NEW: DIRECT DISC 500 P / 600 P.
Tidy, accurate mowing with MAX-CUT mowing bar. Optimal crop flow with paddle roller and high throughput resulting from large intake auger. Ideal range of applications in short and medium-height crops.

All the highlights.
At a glance.



- 1 Outstanding control concept with additional CEBIS features
- 2 CMOTION multifunction control lever
- 3 Engines compliant with Stage IV (Tier 2 / Tier 4) emissions standard
- 4 Diesel tank capacity of up to 1,500 l for extended working
- 5 Increased efficiency with CRUISE PILOT
- 6 Functional design
- 7 DYNAMIC COOLING
- 8 Automatic engine speed reduction
- 9 DYNAMIC POWER
- 10 Differential lock
- 11 Double hydrostatic motor for ground drive
- 12 Automatic parking brake
- 13 Tyre pressure adjustment system for drive axle and steering axle
- 14 Variable front attachment drive
- 15 COMFORT CUT with infinitely variable chop length adjustment
- 16 NEW: Hydraulic precompression
- 17 NEW: V-MAX with relocatable knife carriers
- 18 Hydraulic shear bar locking
- 19 Automatic adjustment of drum concave
- 20 Knife sharpening system with throughput-based reminder function
- 21 Corncracker concept: MCC CLASSIC, MCC MAX, MCC SHREDLAGE®
- 22 AUTO FILL side and rear offloading
- 23 NEW: Programmed payload detection for forage trailers
- 24 Near infrared sensor system for determination of dry matter
- 25 NEW: PICK UP 380 / 300
- 26 NEW: DIRECT DISC 600 P / 500 P
- 27 Unique accessibility concept for fast and straightforward maintenance

The JAGUAR cab.
See more, hear less.

- Spacious comfort cab with low noise level
- Excellent visibility and lighting
- CEBIS information and control system
- For seat types, including leather seat, for operator and passenger
- CMOTION multifunction control lever for high comfort



The JAGUAR workplace. Command bridge with a view.



The advantages at a glance.

- The CLAAS comfort cab: intuitive operation of your JAGUAR
- Wide range of equipment options
- LED work lights: turn night into day



The CLAAS comfort cab.

In the JAGUAR, there is simply nothing to distract you. The steering column and operator's seat can be adjusted to suit each and every operator. Thanks to the clearly laid-out displays and controls, you will feel at home in the JAGUAR in no time.

Wide range of equipment variants.

Roller sunblinds, air conditioning, a radio and a coolbox also help to keep operators fresh and alert, no matter how long they are on board.

- Spacious VISTA CAB with two seats
- Top seating comfort with a choice of the comfort seat, swivelling seat, leather seat or the heated and ventilated premium seat
- Clear view all-round

Optional comfort package.

The special insulation on the rear window minimises noise without compromising the all-round visibility. An exclusive windscreen made from laminated safety glass reduces reflections in the cab, especially in the dark and in rainy conditions.

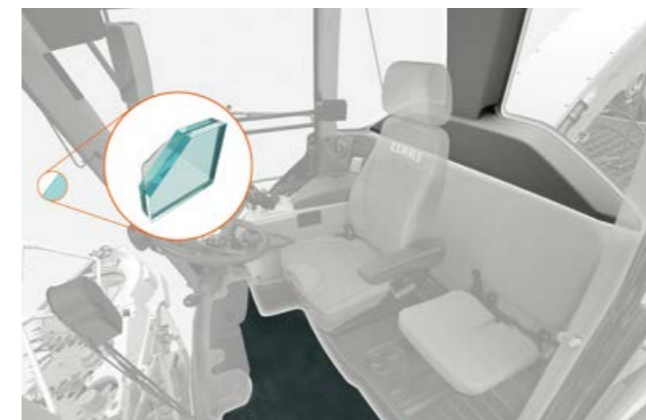

LED work lights.

LED work lights on the cab roof, at the rear and on the discharge spout where they pivot with the crop flow allow nighttime harvesting operations to be monitored very easily.

- Very even illumination
- The white light is similar to daylight



The electronic control centre.
Everything under control and at your fingertips.



CMOTION multifunction control lever

- 1 Intake on
- 2 Stop intake and reverse with CMOTION:
 - First stage: stop and reverse front attachment
 - Second stage: reverse front attachment and intake
- 3 Discharge spout control
- 4 Front attachment height setting
- 5 Automatic spout swivel
- 6 AUTO FILL / spout park position
- 7 AUTO PILOT

CEBIS control

- 8 CEBIS direct menu rotary switch
- 9 CEBIS menu selection rotary switch
- 10 Escape button
- 11 HOTKEY direct menu rotary switch
- 12 HOTKEY rotary / push switch
- 13 Information button
- 14 DIRECT ACCESS button

Crop flow

- 15 Raise / lower discharge spout
- 16 Silage additive system, main switch
- 17 Fold front attachments

Drive

- 18 Chopping system on / off
- 19 Gear shift
- 20 Differential lock
- 21 Parking brake automatic / manual
- 22 POWER TRAC all-wheel drive
- 23 Diesel engine speed (three steps)

CEBIS: CLAAS electronic on-board information system.

The clear, user-friendly structure of the control system ensures that you can manage the JAGUAR confidently and easily in all conditions. All the main functions are controlled and monitored through just a few central elements. At the heart of this well thought-out design is CEBIS, providing a logical and ergonomic interface with every conceivable detail taken into account.

- The CEBIS rotary switch is used to control the basic functions
- The additional HOTKEY direct menu rotary switch allows another important function to be controlled
- All switch functions have logical, self-explanatory icons
- A CompactFlash Card makes data exchange particularly easy
- Your hand rests easily on the multifunction lever where you have instant control over the driving speed, as well as numerous other functions

NEW: Programmed payload detection for forage trailers.

You can program the payload of three forage trailers. CEBIS shows you the load status of the selected trailer and notifies you when the programmed payload level has been attained. This feature helps you avoid overloading forage trailers.

The advantages at a glance.

- CEBIS: the intuitive control hub
- Easily understood symbols
- Data exchange via CF card or TELEMATICS
- CMOTION multifunction control lever



Multifunction control lever



CMOTION multifunction control lever

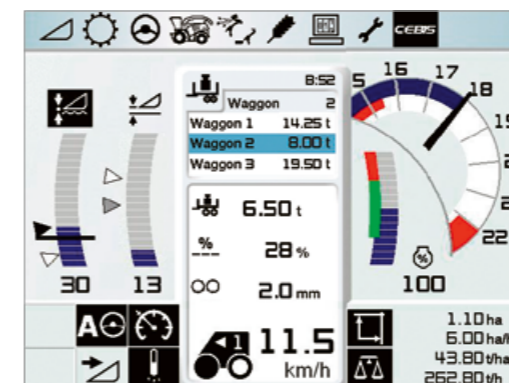

The drive system. Economical power pack.

CPS – CLAAS POWER SYSTEMS.

Optimal drive for best results.

Equipment development at CLAAS means an ongoing effort for even greater efficiency and reliability as well as optimal profitability in the field.

Of course, this applies to all aspects of a CLAAS forage harvester. A case in point is the drive system which is of decisive importance for the performance of the entire machine and which calls for a lot more than just a powerful engine.

In CLAAS POWER SYSTEMS (CPS), we have brought together top-quality components to create a drive system that is in a class of its own – one that always delivers the most efficient power when needed. CPS is ideally matched to the work systems, featuring fuel-saving technology that quickly pays for itself.

The intelligent DYNAMIC POWER engine control system from CLAAS provides the best possible implementation of the CPS philosophy: optimal, automatic provision of the appropriate power for the JAGUAR in line with requirements. It is another example of our approach to achieving real fuel savings. The decisive factor is not the engine itself but the ability to control the available output intelligently – so you can do more with less.



The engine technology.
Up to 884 hp in one block.

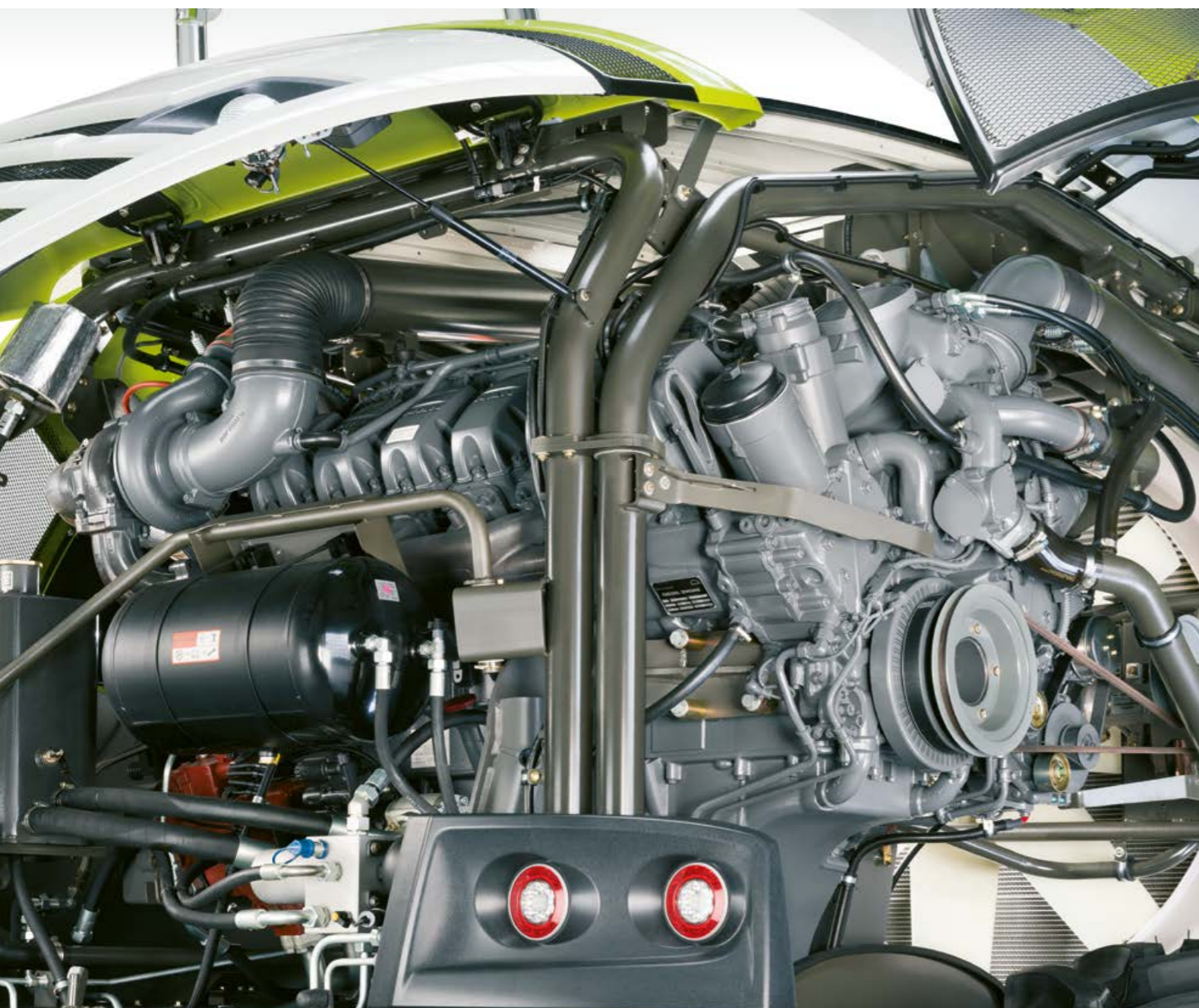

MAN or Mercedes-Benz technology.

The large MAN V12 and V8 engines are fitted in the JAGUAR 980 and the JAGUAR 970. These engines are distinguished by their extremely smooth running characteristics and exceptional efficiency. As the MAN engines have outputs in excess of 560 kW, they are not subject to exhaust emission regulations. The JAGUAR 960 to 930 models have to comply with the Stage IV (Tier 4) emissions standard. The Mercedes-Benz six-cylinder in-line engines require an exhaust gas aftertreatment system downstream from the engine in order to comply with this standard.

This system uses the selective catalytic reduction (SCR) principle to convert the nitrogen oxides in the exhaust flow into nitrogen and water. The urea solution necessary for this is carried in a 130-litre tank. Urea consumption is about 3% of the diesel consumption. The latest technology which features in the six-cylinder in-line engines from Mercedes-Benz includes such highlights as:

- Common rail, high-pressure injection technology (up to 2500 bar)
- A displacement of 15.6 l as well as turbo-compound technology for maximum efficiency at full load
- Torque is consistent over a wide engine speed range
- Low weight thanks to high power density
- Very low diesel consumption
- Compliance with emissions standards by means of SCR technology



High-capacity fuel tank.

JAGUAR	Diesel tank	Auxiliary diesel tank	Diesel, total	Urea tank
980-970	1200 l	300 l	1500 l	-
960-930	1050 l	300 l	1350 l	130 l

High engine output.

JAGUAR engines	Type	Stage IV (Tier 4)		Displacement litres
		kW	hp	
980 with MAN V12	D2662	650	884	24.24
970 with MAN V8	D2868	570	775	16.16
960 with MB S6	OM 473	460	626	15.6
950 with MB S6	OM 473	430	585	15.6
940 with MB S6	OM 471	380	516	12.8
930 with MB S6	OM 471	340	462	12.8

CLAAS POWER SYSTEMS.

CPS encompasses the full range of drive technology and matches it with the appropriate engine to form an optimally tuned drive system. This results in the highest level of efficiency available in the market.



MAN V12 D2662



MAN V8 D2868



Mercedes-Benz OM 473



Mercedes-Benz OM 471

DYNAMIC COOLING.

Effective cooling.

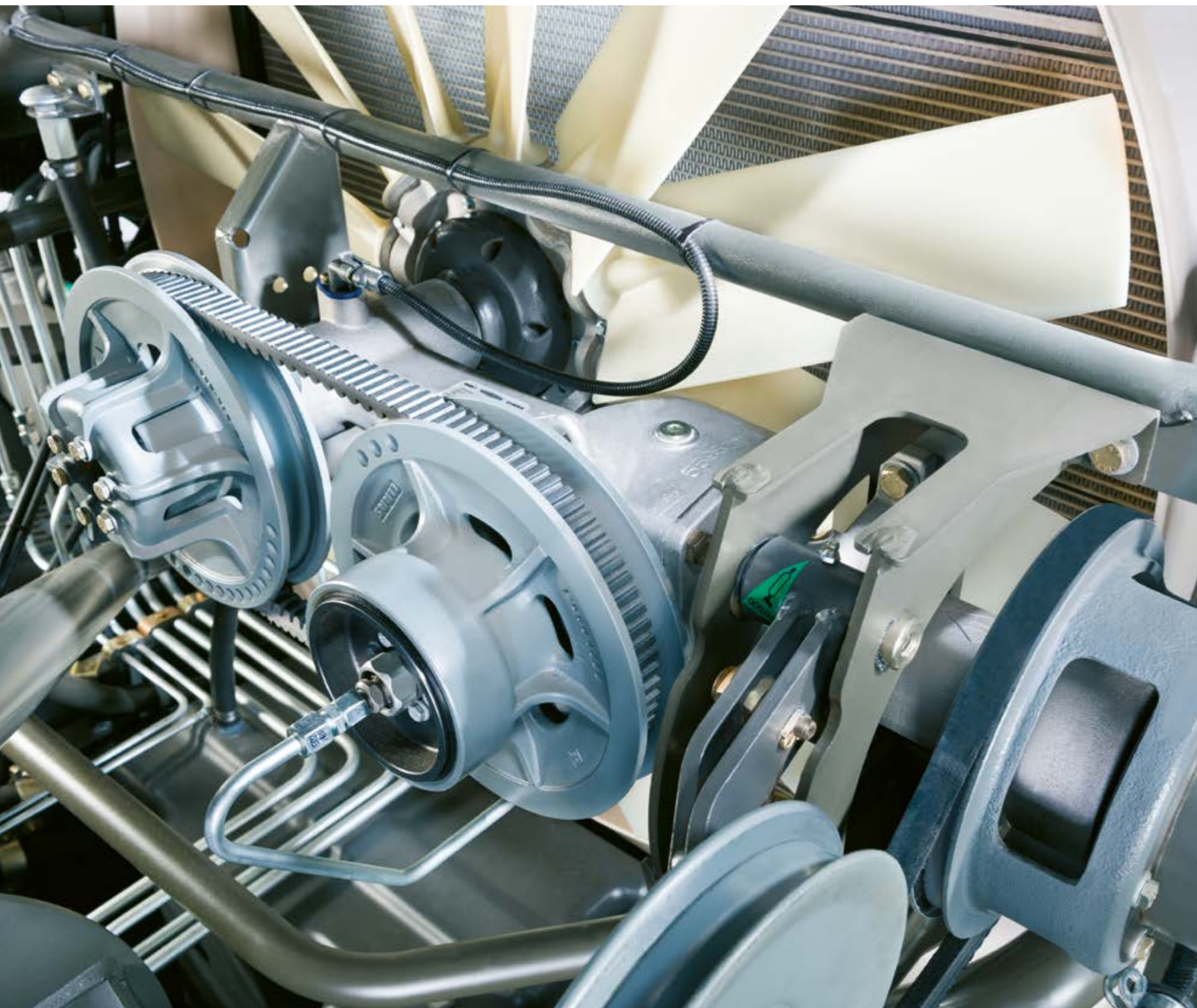

Dynamic cooling system saves fuel.

A highly efficient variator drive is available as an option for the JAGUAR 900 model series. DYNAMIC COOLING identifies the requirements of all three cooling units: engine coolant, charge-air cooling system and hydraulic oil system. When operating at partial load or on the road, a reduced fan speed is often perfectly sufficient. In this way, it is possible to save up to 20 kW: so you save on fuel.

In very hot regions, DYNAMIC COOLING can even enable an increase in fan performance of up to 15% compared with the conventional cooling system. This ensures a sustained high level of cooling performance.

Clean cooling.

In the JAGUAR, horizontal slab radiators provide effective cooling under all harvesting conditions. The large surface area of the radiator screen keeps air speeds down, thereby reducing dirt build-up. A rotating extractor arm keeps the screen clean.

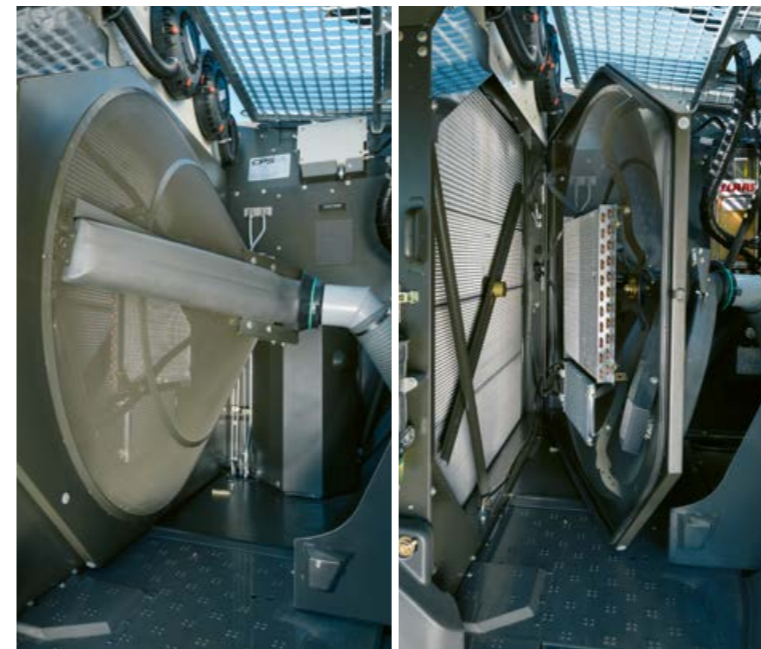

Functional design.

The airflow from the fan is directed past the engine and can escape practically unhindered through the large rear air outlet formed from expanded metal grilles. As a result, the JAGUAR can be counted on to cope reliably with challenging demands, even in extremely hot weather.

The advantages at a glance.

- DYNAMIC COOLING.
Only as much cooling as necessary
- Power saving of up to 20 kW
- Fan speed reserve of up to 15% for performance peaks



CRUISE PILOT.

Maximum output – automatically.



Optimal engine load.

The automatic control of the ground speed by CRUISE PILOT allows the engine load to be used to the full. The operator specifies the desired engine load in CEBIS by setting the corresponding engine speed. CRUISE PILOT is activated easily by means of the multifunction control lever. The JAGUAR now adjusts its performance to operate at the set engine load all the time. If the crop suddenly becomes more dense, the ground speed is reduced automatically. If the crop density diminishes again, the JAGUAR increases the ground speed until the preset engine output is attained. This automatic adjustment is based on the detection of the throughput and the engine load.

CRUISE PILOT is an operating mode. You choose the appropriate strategy:

- Cruise control
- Constant throughput
- Engine load

You can use the HOTKEY direct menu rotary switch to adjust the selected mode in accordance with the operating conditions while the machine is running.

- Greatly eases the operator's workload
- JAGUAR performs at maximum efficiency

The advantages at a glance.

- Greatly eases the operator's workload
- Activation of CRUISE PILOT by means of the multifunction control lever
- Constant throughput with optimal engine efficiency

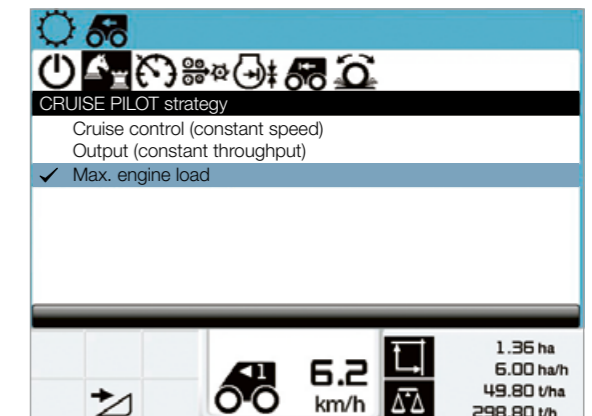
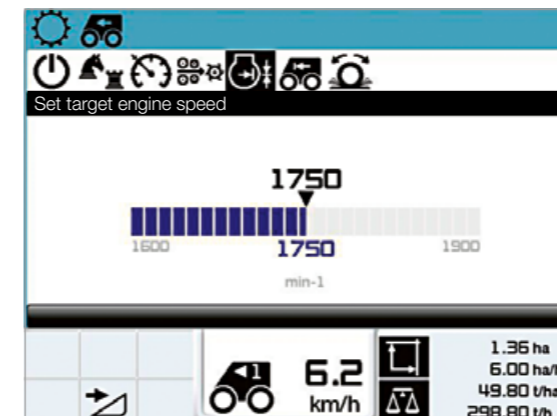

DYNAMIC POWER.

Appropriate efficiency, low consumption.



Automatic adjustment of engine output.

The JAGUAR 980 to 940 models can be equipped with the DYNAMIC POWER automatic engine output control system.

Maximum efficiency and throughput are attained when operating at full load. In the partial load range, the engine output is reduced automatically. This makes it possible to achieve fuel savings of up to 10.6%.

Before entering the crop, DYNAMIC POWER switches to the maximum engine output. This is made possible through the intelligent combination of the engine load, ground speed and working position.

If maximum power is no longer required after entering the crop, DYNAMIC POWER reduces the output to the appropriate setting.

DYNAMIC POWER adjusts the engine output optimally to the field conditions in ten steps. This ensures that you are always operating in the most efficient engine speed range.

- Save diesel during partial-load operation
- Economical, consistent working with cruise control

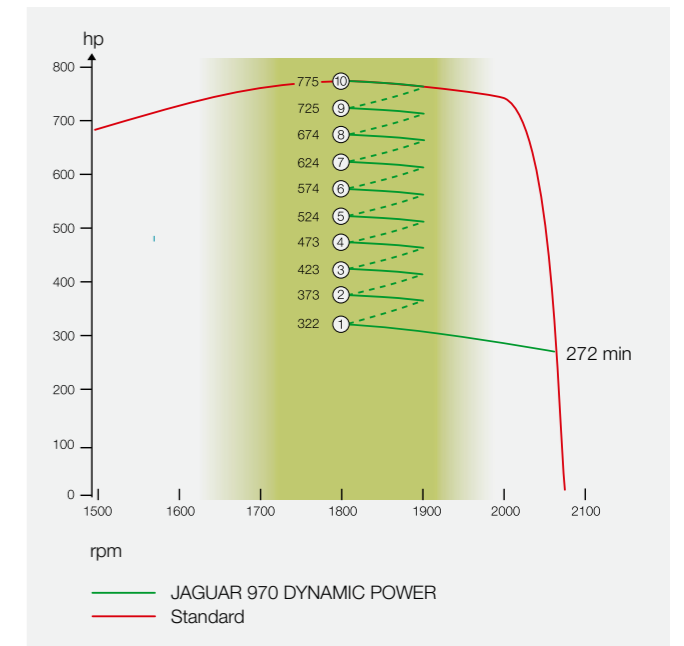

Engine output in hp.

Selectable	JAGUAR step	980	970	960	950	940
Maximum output	10	884	775	626	585	516
	9	823	725	591	554	492
	8	762	674	555	522	467
High output	7	700	624	520	491	443
	6	639	574	484	460	418
	5	578	524	449	429	394
Normal output	4	517	473	414	397	370
	3	455	423	378	366	345
	2	394	373	343	335	321
	1	333	322	307	303	296
at least		272	272	272	272	272

The advantages at a glance.

- DYNAMIC POWER: automatic engine output control
- Save diesel during partial-load operation

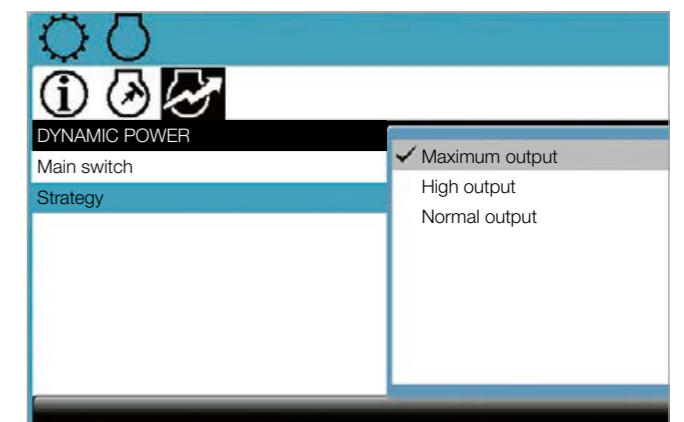
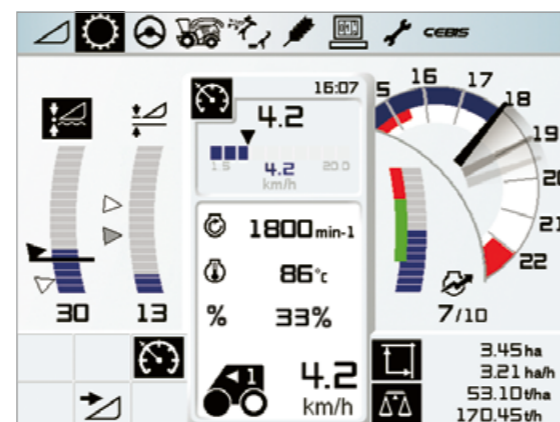

The running gear.

Designed to put the power down optimally.

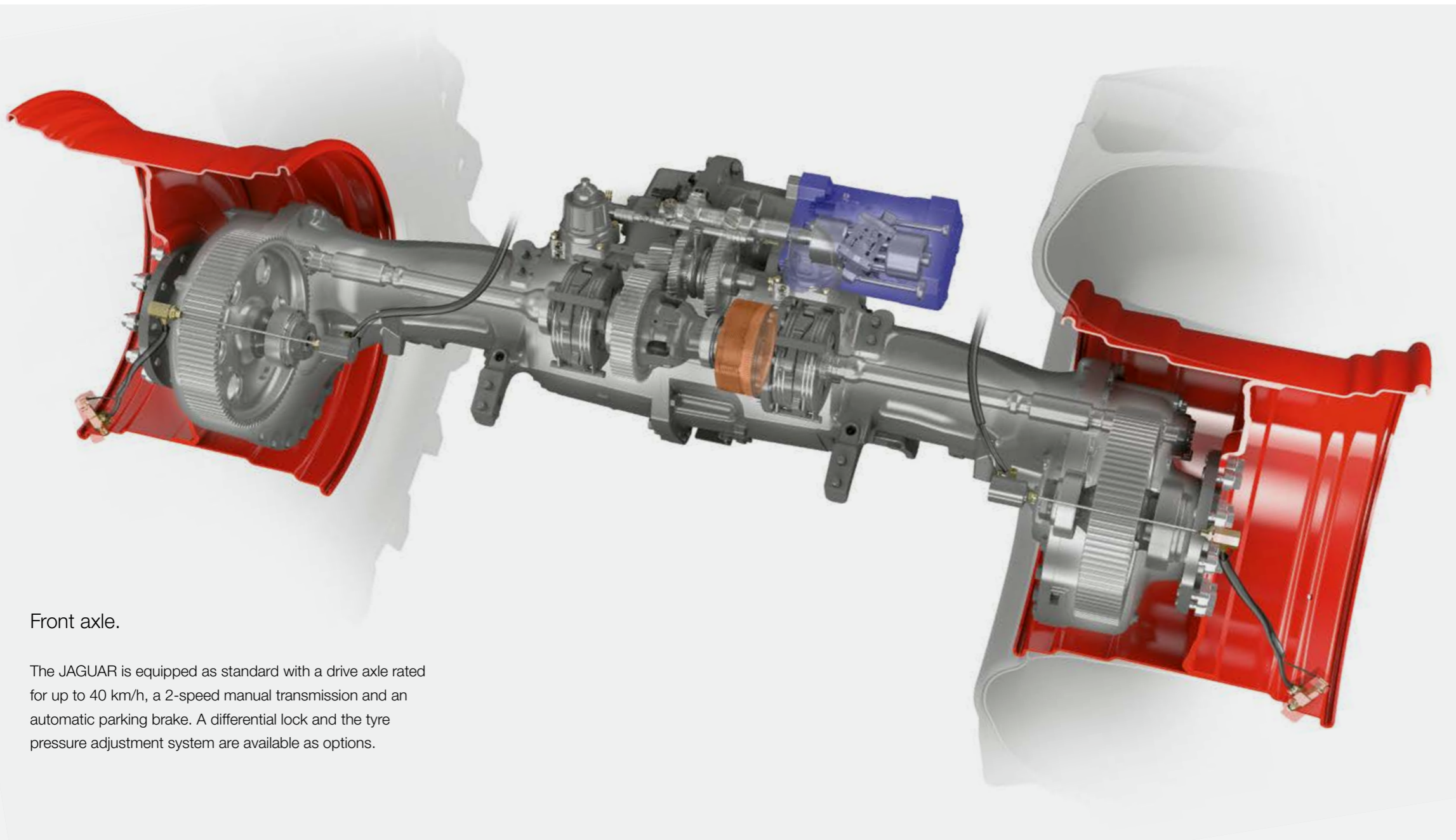

Front axle.

The JAGUAR is equipped as standard with a drive axle rated for up to 40 km/h, a 2-speed manual transmission and an automatic parking brake. A differential lock and the tyre pressure adjustment system are available as options.

The advantages at a glance.

- Robust drive axle
- Double hydrostatic motor with wide speed range
- Differential lock for improved traction
- Automatic parking brake for enhanced safety and convenience

Double hydrostatic motor with wide speed range.

Advantages of a double hydrostatic motor for the drive axle:

- Speed of up to 22 km/h possible in first gear – increased operational flexibility and greater comfort and convenience during field work
- The automatic reduction of up to 1400 rpm in the diesel engine speed saves fuel when turning at the headland or when stopping for the changeover of an offloading trailer
- During on-road travel, an engine speed of just 1290 rpm reduces fuel consumption and engine noise
- Pulls away powerfully on the road, in the field and on slopes

Differential lock.

For improved traction the drive axles can be locked by means of a multi-disc clutch. The operator has a choice of three settings:

- The automatic engagement system recognises when a wheel on the drive axle is slipping and locks the front axle automatically. Recommended when harvesting with AUTO PILOT.
- The automatic disengagement system keeps the clutch closed, only opening it if the speed exceeds 15 km/h, if there a steering correction or if braking occurs. This function is an advantage in difficult terrain.
- Manual engagement is suitable for short-term use in very heavy-going and difficult terrain

Automatic parking brake.

If the multifunction control lever is in the neutral position, the parking brake is actuated automatically when the machine comes to a standstill. This prevents it from rolling away unintentionally on a slope. Furthermore, gear changing can be carried out comfortably without having to use the brake pedal. Front attachments can be coupled easily thanks to the very sensitive pull-away response.



Tyre pressure adjustment system. Optimal traction at all times.

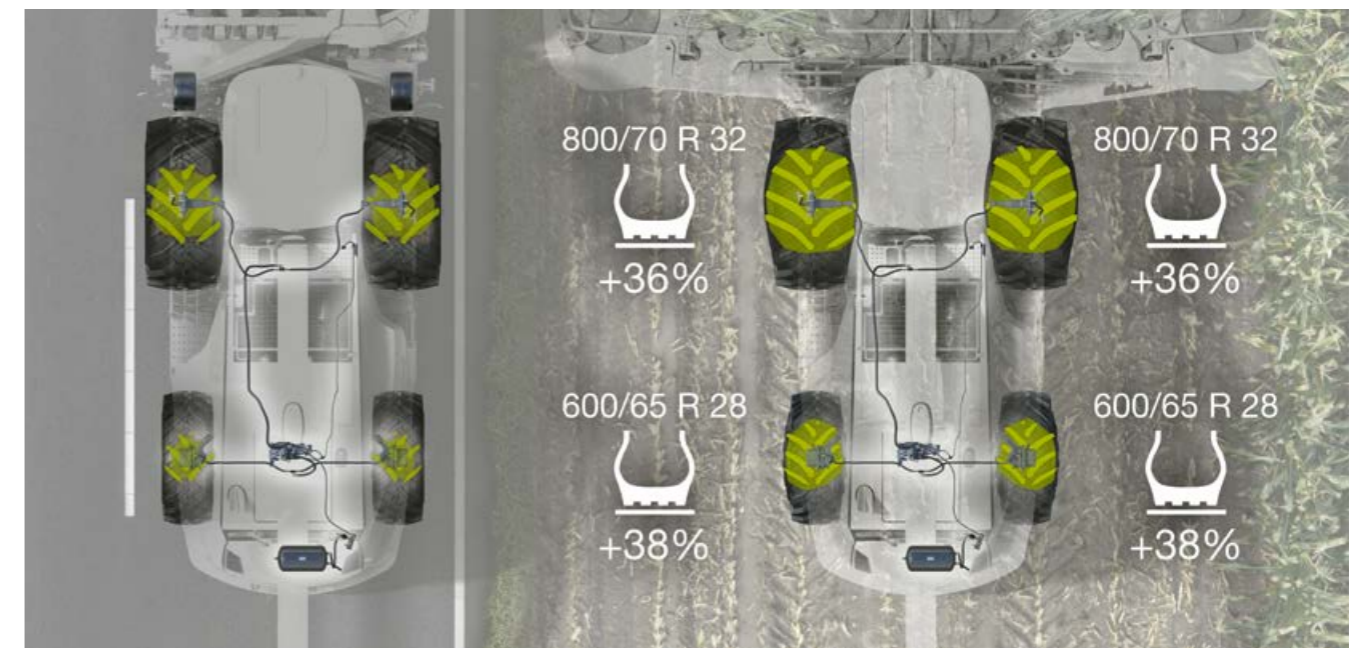

Tyre pressure adjustment system for drive axle and steering axle.

If it starts raining or the ground traction is poor, it is possible to react by adjusting the pressure of the front tyres conveniently from the cab. Furthermore, adjustment for on-road running and in-field operation takes place automatically. Reduced tyre pressure means that the machine is very gentle on the field while delivering maximum traction and providing an extremely comfortable ride. A field study by the South Westphalia University of Applied Sciences has shown that reducing the tyre pressure makes it possible to reduce ground drive diesel consumption by 5%.

POWER TRAC – all-wheel drive for more pulling power.

If the JAGUAR is operating in classic 2-wheel-drive mode, up to 40% more pulling power can be called on by engaging POWER TRAC. When harvesting with the PICK UP, the traction of the driven steering axle is reduced automatically. This protects the grass cover in all-wheel-drive mode.

High ground clearance and tight turning radius.

On standard tyres, the JAGUAR has a ground clearance of up to 450 mm. Even greater ground clearance is available with the optional, large tyres with a maximum size of 900/60 R 38 and a diameter of 2.05 m at the front and a maximum size of 620/70 R 30 at the rear. Perfect manoeuvring is made possible by the slightly tilted rear axle geometry with a turning radius of as little as 12.50 m (depending on tyres fitted).

The advantages at a glance.

- Exclusive to CLAAS: tyre pressure adjustment system for drive axle and steering axle.
- POWER TRAC for 40% traction engagement with driven steering axle
- Tight turning radius thanks to tilted rear axle geometry



Hydraulics and electrics. Clear layout.

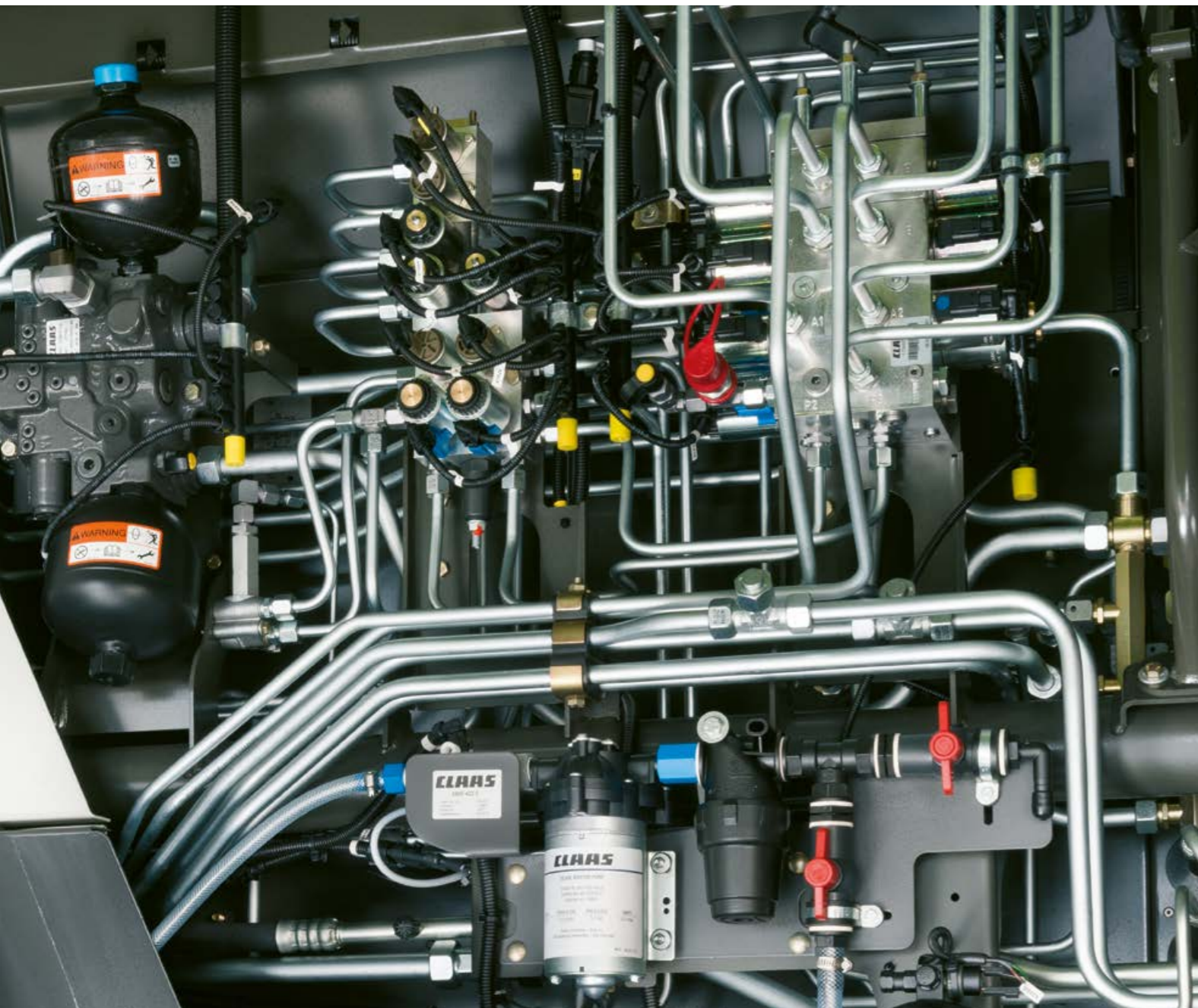

Hydraulics control.

The spool valves are clearly laid out on the left side of the machine. Proportional valves for the discharge spout and front attachment control system allow a smoother response when these systems are functioning automatically. In order to enable a consistent stubble profile, even when operating at very high ground speeds, the raising / lowering speed and the response speed of the ORBIS lateral levelling mechanism, for example, can be adjusted as required in CEBIS.

Vibration damping at the headland.

The vibration damping system is activated automatically once the headland is reached and the front attachment raised past the working height. This additional convenience feature reduces wear and tear on the machine when crossing sprayer wheelings, for example. The front attachment is protected by a correspondingly gentle suspension response.

- Rapid implementation of function commands
- Efficient control by proportional valves
- Cost-effective maintenance thanks to low-volume oil system
- Hydraulic oil only needs to be changed after 1,000 operating hours



Easy-maintenance electrical system.

A straightforward, convenient control concept demands a fast, reliable electrical system. In the JAGUAR, all the key components are housed securely and centrally in the cab. An expansion box in the maintenance compartment of the JAGUAR allows the easy accommodation of additional options when retrofitting:

- PROFI CAM
- AUTO FILL
- ACTISILER 20
- NIR sensor
- QUANTIMETER
- Auxiliary diesel tank, 300 l
- Accelerator gap setting
- Tyre pressure control system
- DYNAMIC COOLING



Expansion box in maintenance compartment

The chopping system. Powerful, precise, razor-sharp.

Peak performance and cost-effectiveness. JAGUAR technology.

- High performance with economical engines
- Straightforward, highly efficient drive system
- COMFORT CUT infinitely variable chop length adjustment
- Variable front attachment drive with automatic speed adjustment in event of chop length modification
- Chopping cylinder features up to 36 knives for first-class, consistent chopping quality
- Automatically adjustable drum concave
- Large, low-noise cab
- Maximum throughput with low power consumption



The drive. Best in class.

Tough, reliable and low-maintenance.

Five features guarantee top efficiency:

- 1 Transverse-mounted engines
- 2 Direct powerband drive from engine to:
 - Chopping assembly
 - Accelerator
 - COMFORT CUT (infinitely variable chop length adjustment)
 - Variable front attachment drive
- 3 The corncracker is driven directly from the accelerator by a powerband
- 4 QUICK STOP – active braking brings the crop flow to a halt quickly when the main drive is disengaged
- 5 The possible front attachment drive types: variable, split-power, standard



The JAGUAR main drive.

The JAGUAR power flow is quite simply the most efficient design on the market. The chopping mechanism is driven directly from the engine's crankshaft via a long, maintenance-free powerband. This design is still unmatched even today, many years after it was developed.

- The precompression roller drive is integrated into the main drive line
- Thanks to the COMFORT CUT precompression roller drive, the operator can adjust the chop to any required length from the comfort of the cab while the machine is underway
- The whole intake is designed for maximum reliability, outstanding durability and a long service life, with rugged drives, large bearings and gears
- The front attachments are attached to the JAGUAR by means of a quick coupling and can be driven in standard, split-power or variable mode

The advantages at a glance.

- The JAGUAR main drive: powerful, robust and requires little maintenance
- The drive system: highest efficiency factor in market comparisons



The crop flow. Straight and fast.

Maximum throughput with low power consumption.

An optimal crop flow is a major factor in determining the daily output. The crop flows in a straight line through the entire machine without any awkward angles. The crop is accelerated further at each step and is centred increasingly by the V-shaped arrangement of the knives and accelerator paddles. This results in maximum performance with minimum power consumption and makes for highly reliable operation. The JAGUAR demonstrates this time after time: with outstanding results – measured in terms of fuel consumption in litres per tonne.

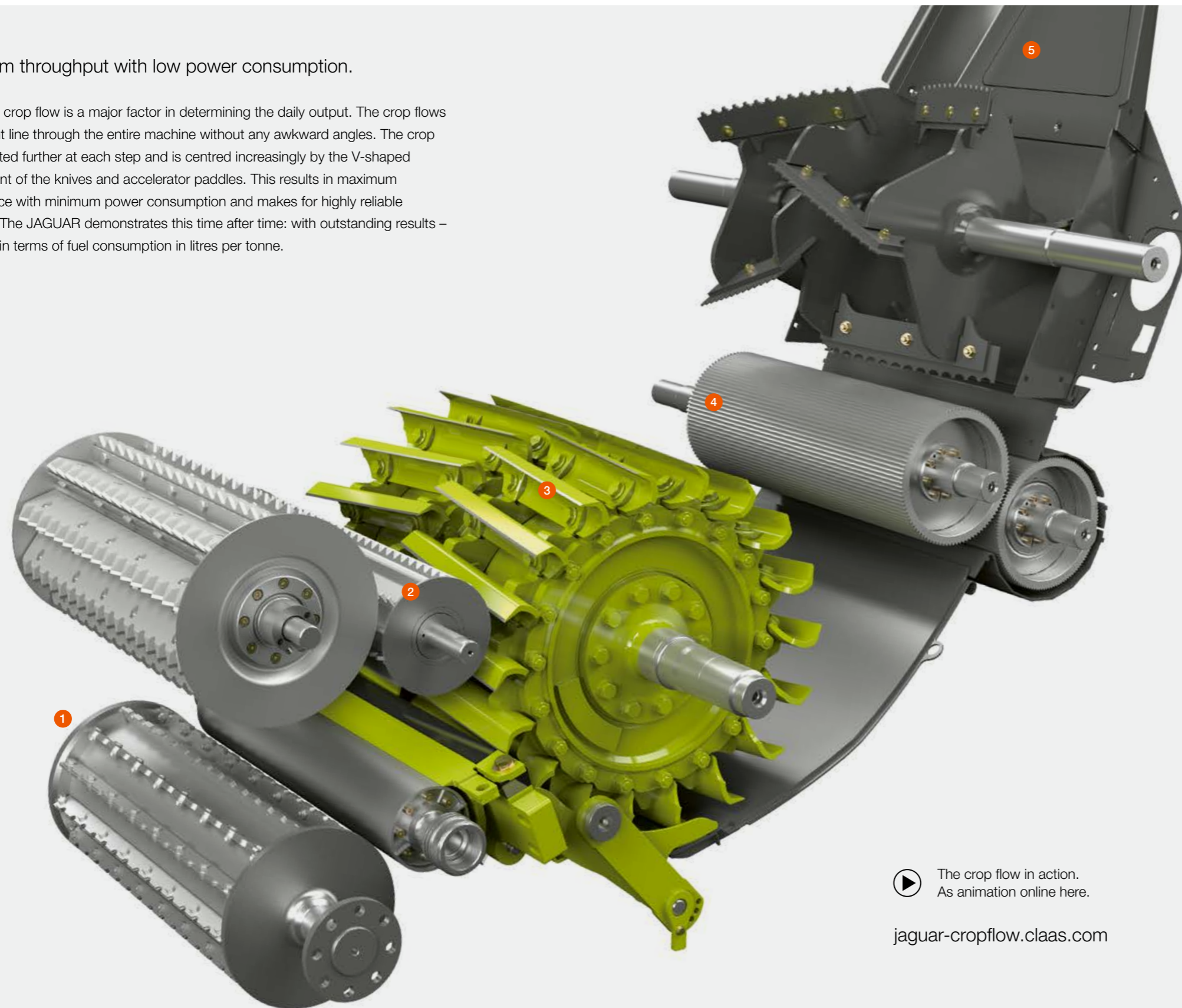

▶ The crop flow in action.
As animation online here.

jaguar-cropflow.claas.com



- 1 Front attachment
 - Variable front attachment drive enables consistent crop flow from front attachment and intake for consistently high chop quality
- 2 Intake
 - Intake rollers with an opening of up to 180 mm for high throughput
 - Hydraulic precompression (optional) for excellent chop quality
 - Chopping cylinder is easily accessible thanks to QUICK ACCESS
- 3 V-MAX chopping cylinder
 - V-MAX knives are attached to the cylinder by tightening the bolts until they lock; no adjustment is necessary
- 4 MULTI CROP CRACKER
 - The right arrangement for a high-quality processing result
- 5 Flexible acceleration
 - Accelerator clearance can be set from the cab, ease of operation for high efficiency

Variable front attachment drive. Something for everyone.

Optimisation of chopped material and crop flow.

CLAAS offers three types of front attachment drive with the 900 model series:

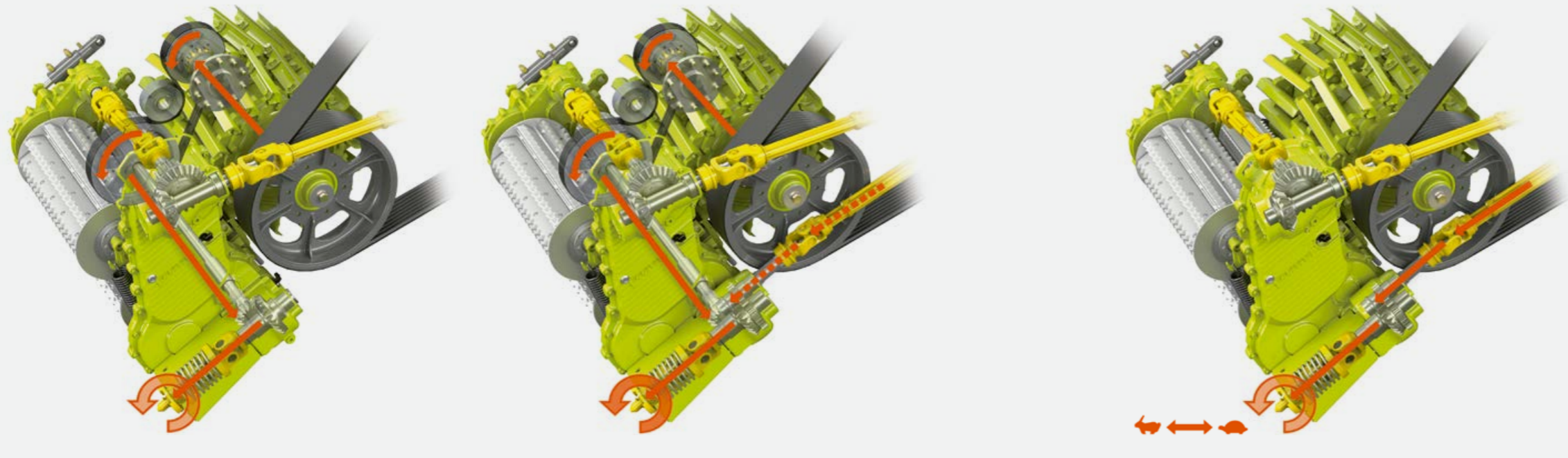

Efficient main drive train.

Like the COMFORT CUT infinitely variable chop length adjustment which can be automated, the variable front attachment drive is integrated in the main drive train. The advantage of this arrangement is that, in the event of any speed variations, the front attachment drive, the intake drive, drum speed, accelerator and corncracker are affected equally. This results in a constant chop length at all times.

1. Mechanical version.

- For all front attachments
- Driven by chopping cylinder shaft, all-mechanical with constant speed, engaged via a belt clutch to the quick coupling
- Excellent efficiency

2. Split-power variant.

- For use with DIRECT DISC or a maize picker
- Mechanical drive via the chopping cylinder shaft and also hydrostatic
- Maximum power transmission at a constant speed

3. Hydraulic front attachment drive.

- For ORBIS maize front attachments and PICK UP
- All-hydrostatic drive
- Optimal crop flow between front attachment unit and intake elements, manual or automatic speed adjustment to the preset chop length with low power requirement
- High efficiency

Two-stage reversing with hydrostatic front attachment drive.

Two-stage reversing is possible in combination with the CMOTION multifunction control lever. Either the front attachment is reversed alone, or the front attachment and the intake are reversed together.

The advantages at a glance.

- Three drive variants
- COMFORT CUT infinitely variable chop length adjustment which can be automated
- Two-stage reversing with hydrostatic front attachment drive

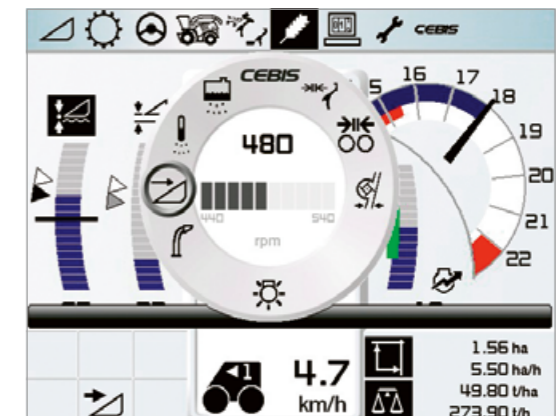
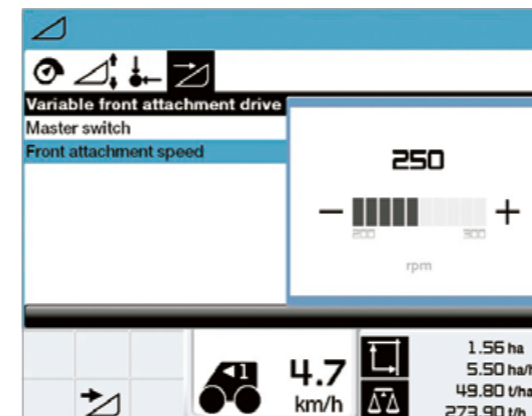

The intake. Consistent high performance.

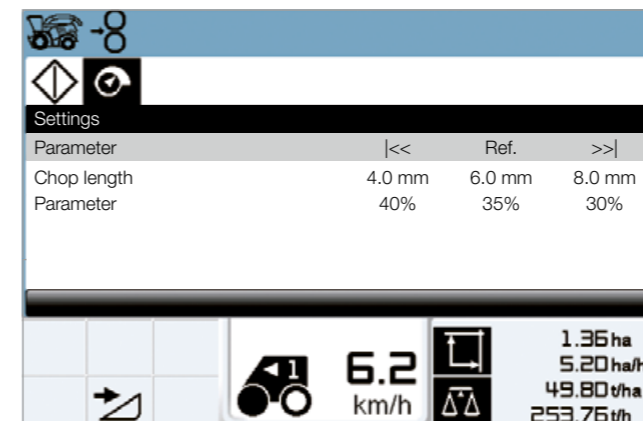

Consistent chop length is maintained.

The intake system of the JAGUAR is powerful, economical and can be adapted to different field conditions. The COMFORT CUT drive is integrated in the main drive train. Its advantage: variations in the engine and cylinder speed are matched by corresponding changes in the COMFORT CUT drive. This results in consistent chop quality at all times. The operator sets the required chop length in CEBIS. The chop length can also be adjusted infinitely during the harvesting process.

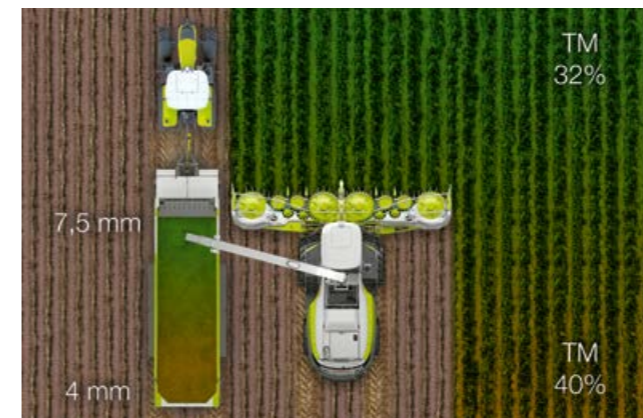

Automatic chop length adjustment.

The chop length can be adjusted in line with the measured dry matter content. The operator can preset the adjustment range in CEBIS. In this way the JAGUAR automatically produces perfect silage for optimum compression in the clamp – even when working areas where the dry matter content of the crop is extremely inconsistent.



Excellent accessibility with QUICK ACCESS.

QUICK ACCESS offers you various options for carrying out maintenance and service tasks rapidly. The intake housing swings open to the side to provide quick and convenient access to the intake and the chopping cylinder for maintenance tasks. Thanks to the quick coupling, the front attachment can be removed rapidly.

The advantages at a glance.

- High-performance drive and powerful reversing
- Infinitely variable chop length adjustment – also automatic on basis of dry matter
- Maintenance-friendly thanks to quick access to chopping assembly



Precompression. Continuous and reliable.



The advantages at a glance.

- Continuous precompression
- Detectors for foreign bodies and magnetic metals
- DIRECT STOP

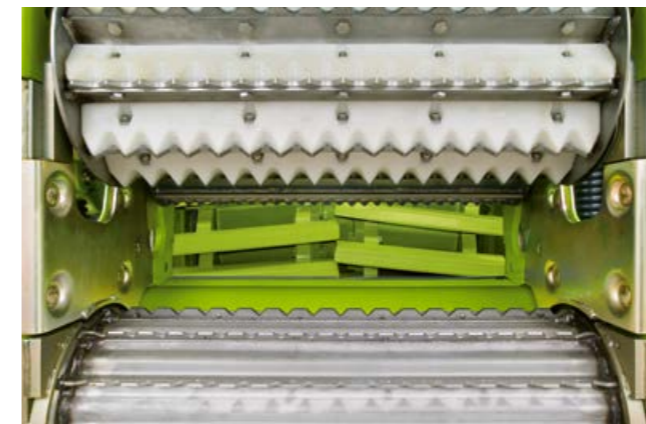

Highly sensitive detectors.

Having a powerful and robust intake is only part of the story – it is also highly sensitive to foreign objects, thanks to the built-in detectors. Now equipped with five magnets, the metal detector protects the JAGUAR against magnetic objects. The detection sensitivity can be adjusted individually, and a pinpointing indication on the CEBIS monitor makes it easier to determine where the object is located.



Additional protection for the JAGUAR is offered by the STOP ROCK detector which stops the intake immediately if it detects a solid foreign body. The operator can set the sensitivity of the detector.

Adjustment of the preset size can be carried out in CEBIS. The wear-free, quick brake for the intake rollers and header works efficiently even when the intake is operating at full speed, enabling the operator to work with confidence.

DIRECT STOP to protect the machine.

When the metal detector or STOP ROCK is activated, the JAGUAR automatically comes to a stop. This quick response prevents the crop from piling up.

Continuous precompression.

The damper (1) in the form of a hydraulic ram is a new addition to the precompression process. This is designed to maintain the even distribution of precompression forces on the upper intake rollers, optimising the efficiency of the overall process. If, for instance, the forward roller is suddenly put out of alignment by an uneven crop feed (swath form), the damper counteracts the deflecting forces on the basis of its reduced oil compensation level.

Consistent precompression.

The intake ram (2) exerts a constant tractive force throughout its travel. This acts as a precompression force directly on the rear upper precompression roller. Unlike spring-based systems, this arrangement ensures that the optimal precompression force is available in every harvesting situation. Unaffected by the crop height, this precompression maintains constant chop quality, notably when entering and leaving the crop stand. Furthermore, the crop flow to the chopping cylinder is more gentle and noticeably more even.

Hydraulic precompression: intelligent, automatic control.

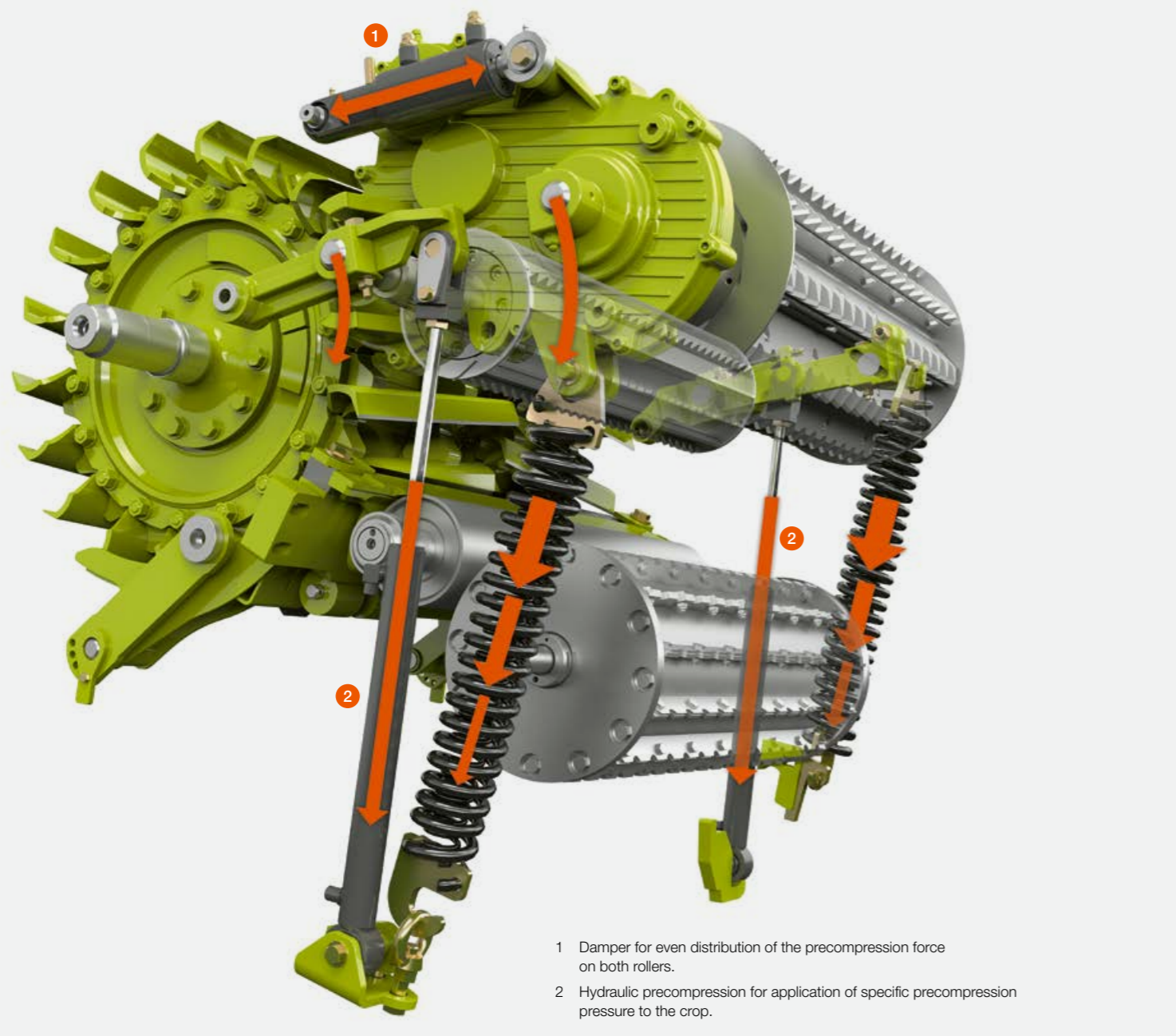

NEW: Intelligent control of hydraulic precompression.

The optional intelligent hydraulic precompression system features two hydraulic rams with a pressure reservoir for the rear upper precompression roller. In this way, a specific precompression pressure is exerted on the crop. Special control characteristics are used to adjust the precompression pressure automatically to different crops and changes in the thickness of the crop flow. The intelligent system automatically determines the appropriate precompression pressure to apply on the basis of:

- the crop type, by means of front attachment detection
- the chop length range
- the particular JAGUAR model (engine output)

When there is a reduction in the thickness of the crop flow, when the JAGUAR has to advance more slowly, when leaving the crop stand or when working in irregular crop stands, for example, the precompression roller always exerts the same pressure on the crop layer. In this way, consistently good chop quality is produced.

If it should prove necessary in certain conditions, it is possible for the operator to use CEBIS to adjust the precompression pressure manually in three steps.

Advantage:

- Ideal preparation of the harvested crop through intelligent precompression control for consistently high chop quality
- Very gentle crop flow
- Reduced driver stress through automatic control
- Quick couplers to disconnect chopping cylinder and precompression housing
- Very convenient maintenance through hydraulically retractable precompression rollers

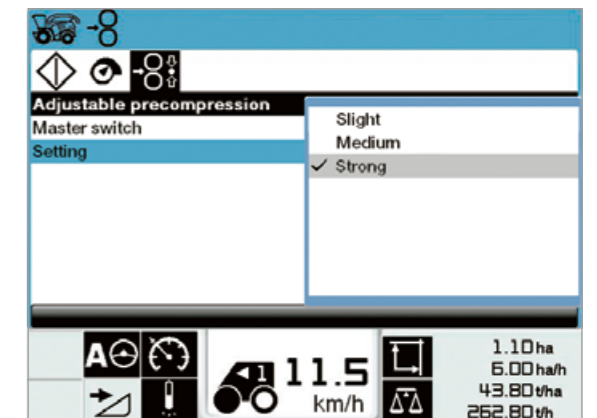
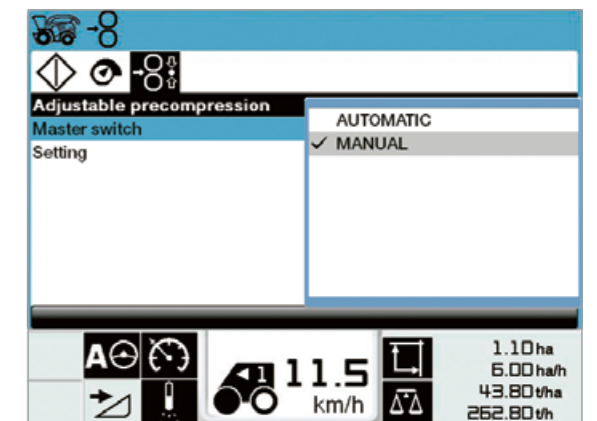

The advantages at a glance.

- Precompression force is automatically adjusted to different crops
- Pressure is maintained at a constant level to ensure optimal chop quality even with low throughput



NEW: V-MAX chopping cylinder. With extended chop length range.

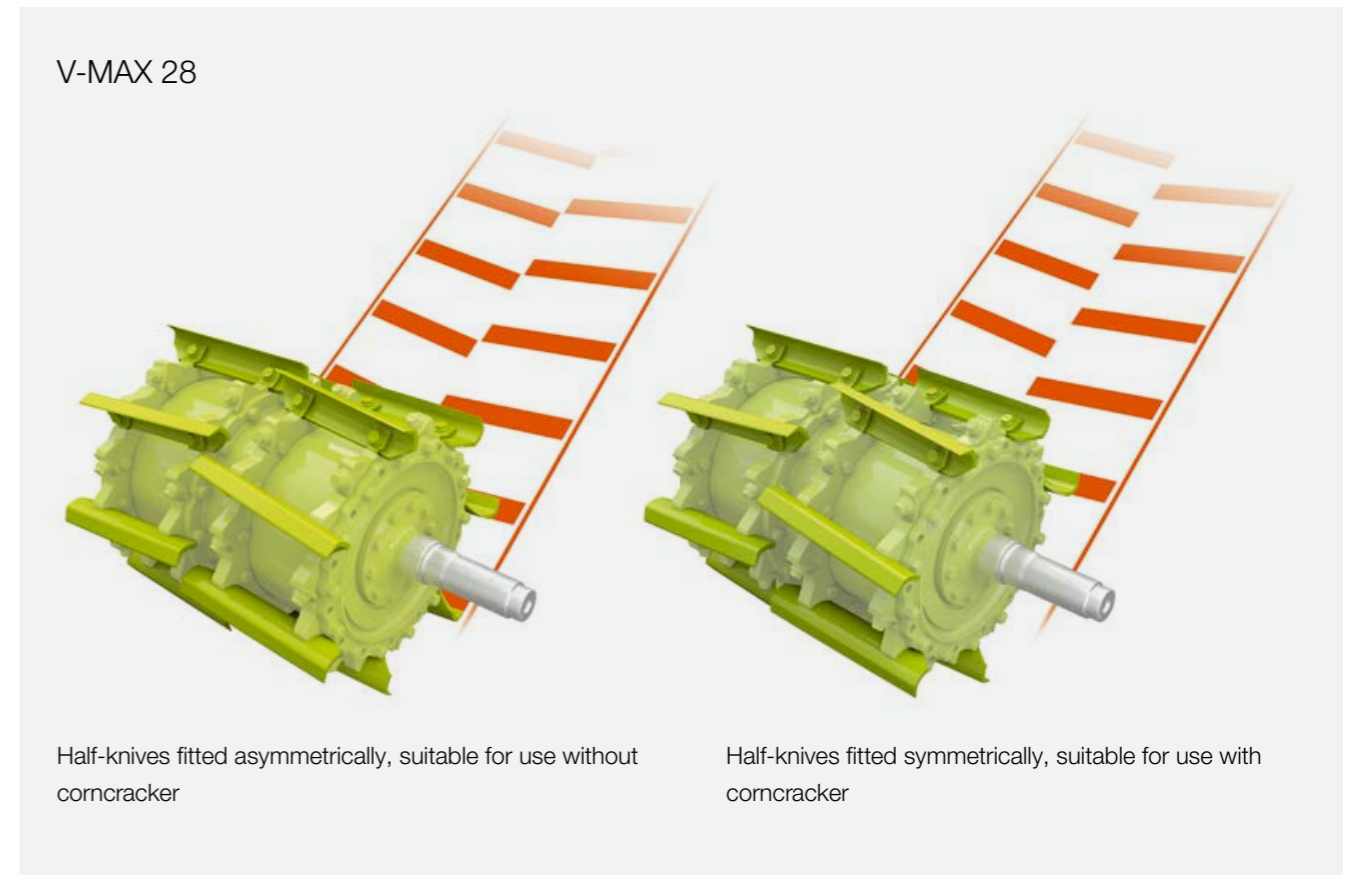

Chop lengths for the V-MAX chopping cylinders.

Cylinder	No. of knives			Chop length range in mm												
	full	half	third	1	5	10	15	20	25	30	35	40	45	50	55	
V 20	20 (2 x 10)	20 (2 x 10)		5 – 26,5					10 – 53							
V 24	24 (2 x 12)	12 (2 x 6)		4 – 22				8 – 44								
V 28	28 (2 x 14)	14 (2 x 7)		4 – 18,5				8 – 37								
V 36	36 (2 x 18)	18 (2 x 9)	12 (2 x 6)	3,5 – 14,5			7 – 18,5				10,5 – 43,5					

The advantages at a glance.

- V-MAX chopping cylinder for optimal chop quality
- NEW: Extended chop length range possible by repositioning knife carriers for use with half the number of knives and corncracker



V-MAX chopping cylinder.

CLAAS offers four variants of the V-MAX chopping cylinders with differing knife configurations in accordance with the different market requirements.

NEW: Highly flexible.

For an extended chop length range, the V-MAX 36 / 28 / 24 can also be used with a corncracker to produce very long chop lengths of up to 30 mm by relocating the knife carriers and halving the number of knives. The resulting symmetrical chop delivery results in high operating reliability and very uniform chop processing by the corncracker.

- Optimum chop quality through precise cutting
- Extremely smooth, power-saving action: the curved shape of the knives makes for an optimum crop flow
- High strength: chopping forces are taken up directly by the star-shaped drum
- Extremely easy to assemble: only two bolts per knife
- There is no need to adjust the knives. They are bolted directly to the star-shaped cylinder with the help of shaped fittings which act as templates.
- No need to adjust the knives
- Relocating the knife carriers and using half the number of knives results in symmetrical chop output when a corncracker is used

The chopping assembly. A sharp operator.

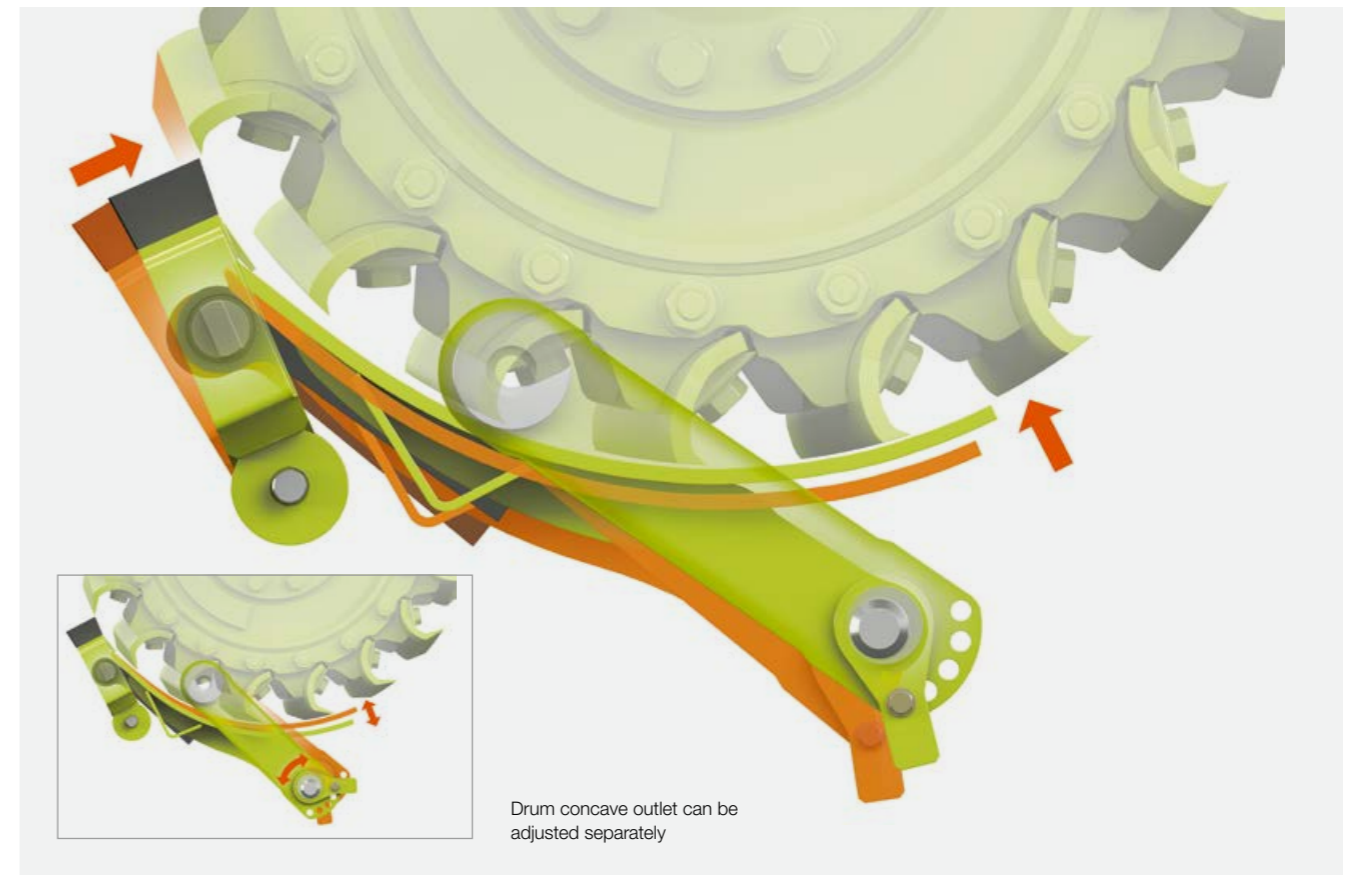
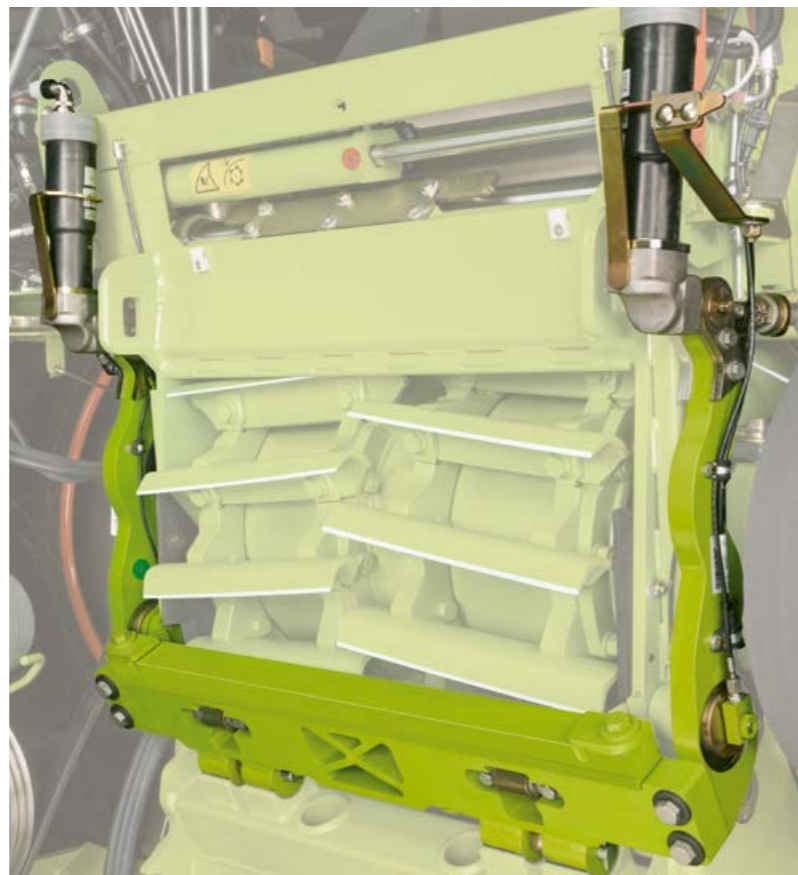

Drum concave outlet can be adjusted separately

Knife sharpening based on throughput.

Knife grinding on basis of time elapsed of throughput? Configure your CEBIS as you require. CEBIS will remind you when knife grinding is necessary on the basis of how you program it. In this way, you can be certain that knife wear is being managed correctly.

Shear bar is locked hydraulically.

The shear bar with the adjustment strip is attached securely to the mounting block by four bolts. In less than 60 seconds, the shear bar with the mounting block is pivoted towards the chopping cylinder which is rotating forwards. This is accomplished by the side shear bar clamp being released hydraulically before being secured again hydraulically after the adjustment procedure. In this way, the exact setting required for precise chopping is maintained reliably.

Automatically adjustable drum concave.

The front of the drum concave is supported on the mounting block while the rear is secured by pivot arms. As soon as the shear bar is adjusted, the drum concave is immediately positioned relative to the chopping cylinder. This arrangement ensures consistent crop delivery during the entire service life of the knives.

Advantages:

- Information on throughput-based knife sharpening
- Precise, even sharpening through exact grindstone guidance
- Outstanding protection from dirt and noise
- Easy adjustment aid for grindstone replacement
- Hydraulic clamping system for shear bar allows reliable chopping
- Automatically adjustable drum concave for consistent crop delivery

Adjustment of drum concave outlet.

The drum concave outlet can be adjusted separately for optimal adaptation to harvest conditions.

The advantages at a glance.

- Knife sharpening based on throughput
- Shear bar secured hydraulically
- Automatically adjustable drum concave



Grindstone adjustment aid

The corncracker.
Optimal processing.

MULTI CROP CRACKER.

The requirements for silage chop length and processing differ widely depending on the individual farm and the purpose for which the silage is to be used. The spectrum extends from extremely short chop lengths of between 3.5 and 12 mm all the way up to the SHREDLAGE® process with lengths of up to 30 mm.



MULTI CROP CRACKER.

Three specialists for top-quality results.

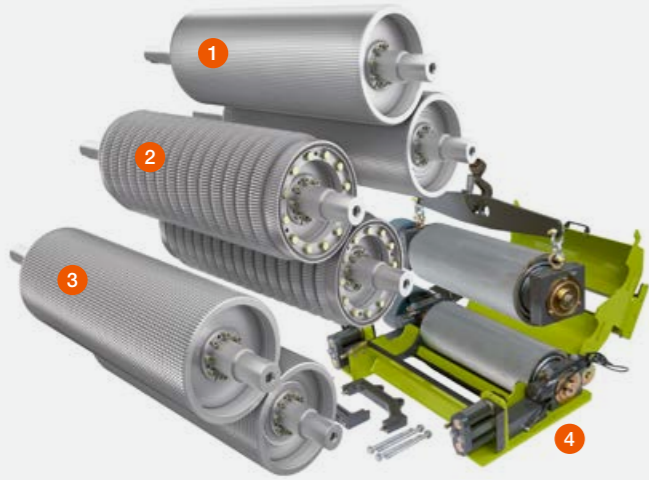

- 1 MCC CLASSIC
- 2 MCC MAX
- 3 MCC SHREDLAGE
- 4 MULTI CROP CRACKER

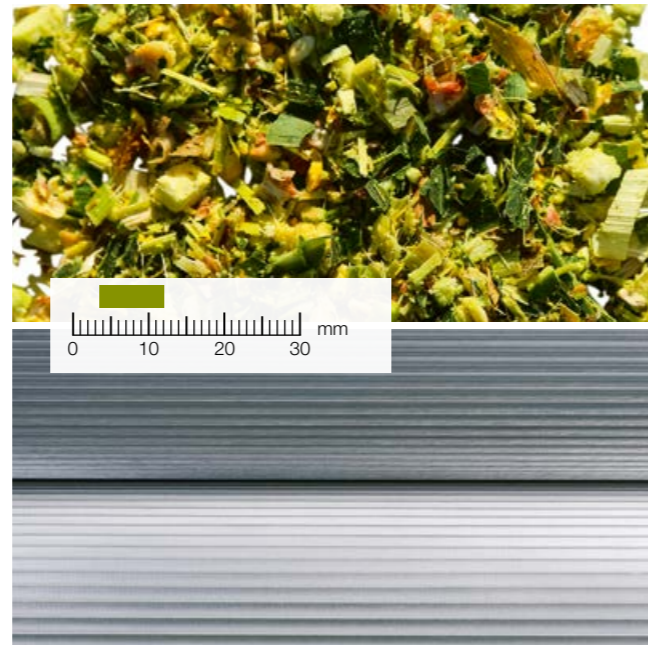

MCC CLASSIC.

The conventional MCC CLASSIC is equipped with the familiar sawtooth profile and operates as standard with a speed differential of 30%. This system is used successfully for harvesting short maize for applications such as biogas facilities, but also for the production of silage as feed for dairy cattle and for bull fattening. Other rollers with a different number of teeth are used in markets where there is a greater need for long-chopped maize silage. The required degree of silage processing is achieved by increasing the speed differential.



MCC MAX.

The MCC MAX rollers have been developed to process maize silage with chop lengths between 7 and 22 mm. They consist of 30 annular segments with a sawtooth profile. The arrangement and special geometry of the annular segments ensure that the crop is processed not only by crushing and friction, but also by cutting and shearing forces. This allows more intensive processing of the maize kernels and also produces a fibrous breakdown of the stalk fragments.

When compared with conventional corncrackers, the range of applications for the MCC MAX covers much greater chop lengths and types of dry matter, while still delivering very high-quality processing results. The MCC MAX provides contractors, machinery rings and farms with a new technical solution which allows them to meet the most diverse customer requirements for forage processing.

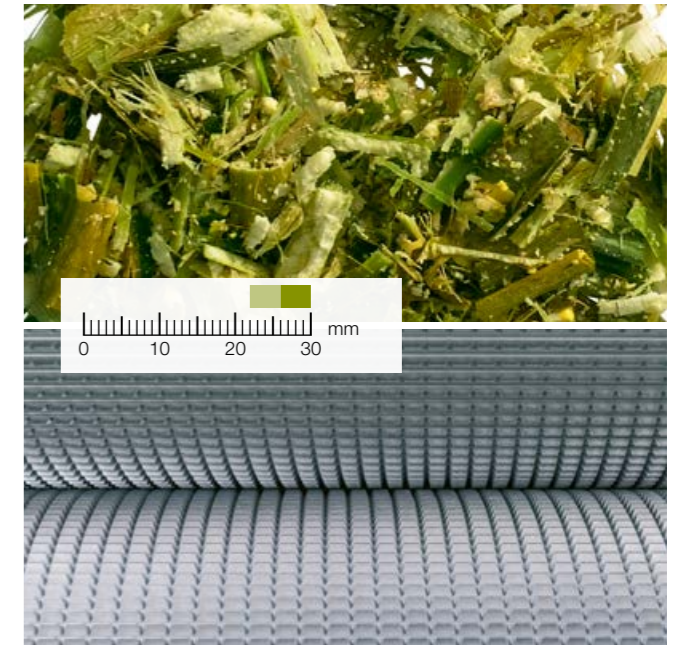

MCC SHREDLAGE®.

SHREDLAGE® is a CLAAS brand. Originally developed in the US, this technology is now responsible for SHREDLAGE® silage being used on many farms around the world. SHREDLAGE® is a maize silage conditioning system in the extremely long chop length range of 26 to 30 mm. Operating with a speed differential of 50%, the SHREDLAGE® rollers have a sawtooth profile with a counterdirectional spiral groove. In this way, the MCC SHREDLAGE® is able to grind the maize kernels thoroughly and chop up the cob fragments completely.

Leaves are well shredded and the stalk material is subjected to a lateral effect by the spiral groove which causes the bark to be rubbed off the stalk. At the same time, the soft inner core is split lengthways. The "shredded" crop can be compressed very well as the structure of the processed material keeps any rebound effect to a minimum.

The advantages at a glance.

- MCC CLASSIC: conventional, chop lengths from 3.5 to 12 mm
- MCC MAX: universal, short and long chop lengths from 7 to 22 mm
- MCC SHREDLAGE®: extremely long chop lengths from 26 to 30 mm

Product range MCC concept	MULTI CROP CRACKER			
	CLASSIC	MAX	SHREDLAGE®	
Roller diameter				
Medium (M)	Ø 196 mm	□	–	□
Large (L)	Ø 250 mm	□	□	□

□ Available – Not available

Always the right solution. Whether short chopping, long chopping or SHREDLAGE®.

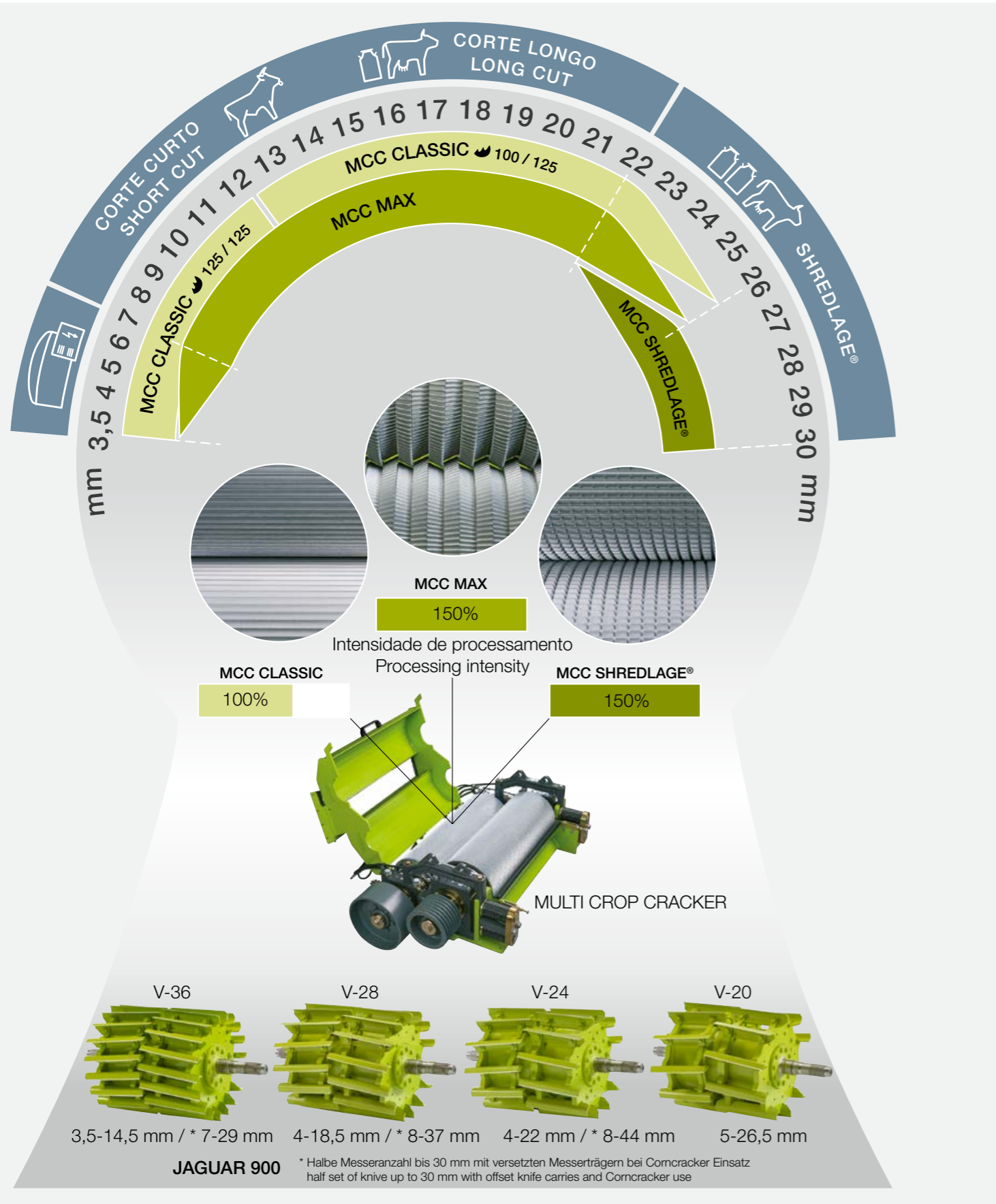

MULTI CROP CRACKER modes of action	CLASSIC	MAX	SHREDLAGE®
Cracker roller gap adjustable for required processing intensity	☐	☐	☐
Number of teeth per roller for crop take-up and kernel size	125 / 125 for 250 mm Ø 100 / 100 for 196 mm Ø	120 / 130 for 245 / 265 mm Ø	110 / 145 for 250 mm Ø 95 / 120 for 196 mm Ø
Roller speed difference for frictional effect	30 %	30 %	50 %
Ring segments engage to produce cutting effect	–	☐	–
Slanting teeth of ring segments produce shear effect	–	☐	–
Counterdirectional spiral groove for peeling effect	–	–	☐

☐ Available – Not available

SHREDLAGE® maize silage.

The intensive processing multiplies the surface of the chopped material many times, resulting in significantly improved bacterial fermentation during ensiling and, above all, during digestion in the cow's rumen. Trials conducted by the University of Wisconsin in Madison showed that SHREDLAGE® drastically increases the physical effectiveness of maize silage in the rumen while also improving the availability of the starch contained in all parts of the plant. Furthermore, the rumen-friendly structure of the silage promoted herd health.

SHREDLAGE® offers dairy producers other benefits in addition to improved livestock health. As the availability of starch is optimised, it is possible to reduce the quantity of feed concentrate used. It is also possible to limit or even eliminate the use of fibre supplements such as straw, thereby providing further scope for cost savings. Please note that the advice of the responsible feed consultant must always be sought in each individual case.

Choose the correct roller gap.

Only as intensive as necessary – this principle should always be kept in mind. It also applies to the roller gap setting and the intensity of the chopped material processing. More intensive crop processing increases the amount of energy required by the JAGUAR. The additional harvesting cost this causes needs to be taken into account.

- Unique product range
- Easy installation and removal thanks to outstanding accessibility
- Extremely rugged design through large bearing units and sealed housing
- High throughput with optimum chop processing
- Outstanding accessibility for maintenance or replacement of rollers
- Continuous, maintenance-free hydraulic belt tensioning for maximum power transmission

▶ Shredlage in action.
More information online here:

shredlage.claas.com

The discharge spout.
This is how easy precise discharging can be.



Crop accelerator and discharge spout. Energy-saving and accessible.

Acceleration the energy-saving way.

The accelerator is ideally positioned in the JAGUAR for optimum performance of its task. The crop flow does not have to negotiate any awkward angles and is centred by the V-shaped accelerator paddles. This reduces the energy requirement and wear to the side walls.

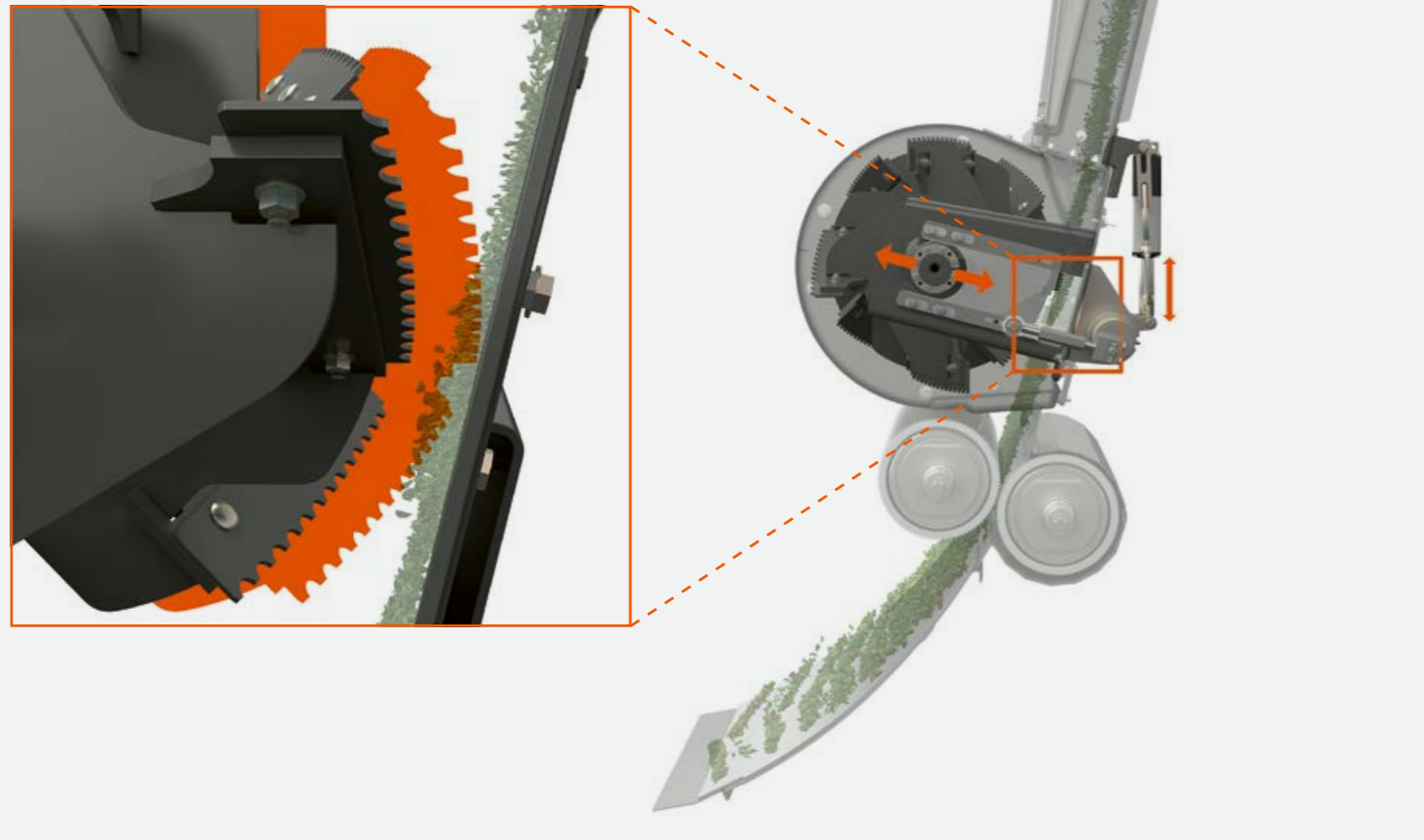

The advantages at a glance.

- Acceleration the energy-saving way
- The discharge spout: modular design
- OPTI FILL: extremely user-friendly



Straightforward removal and installation of the accelerator

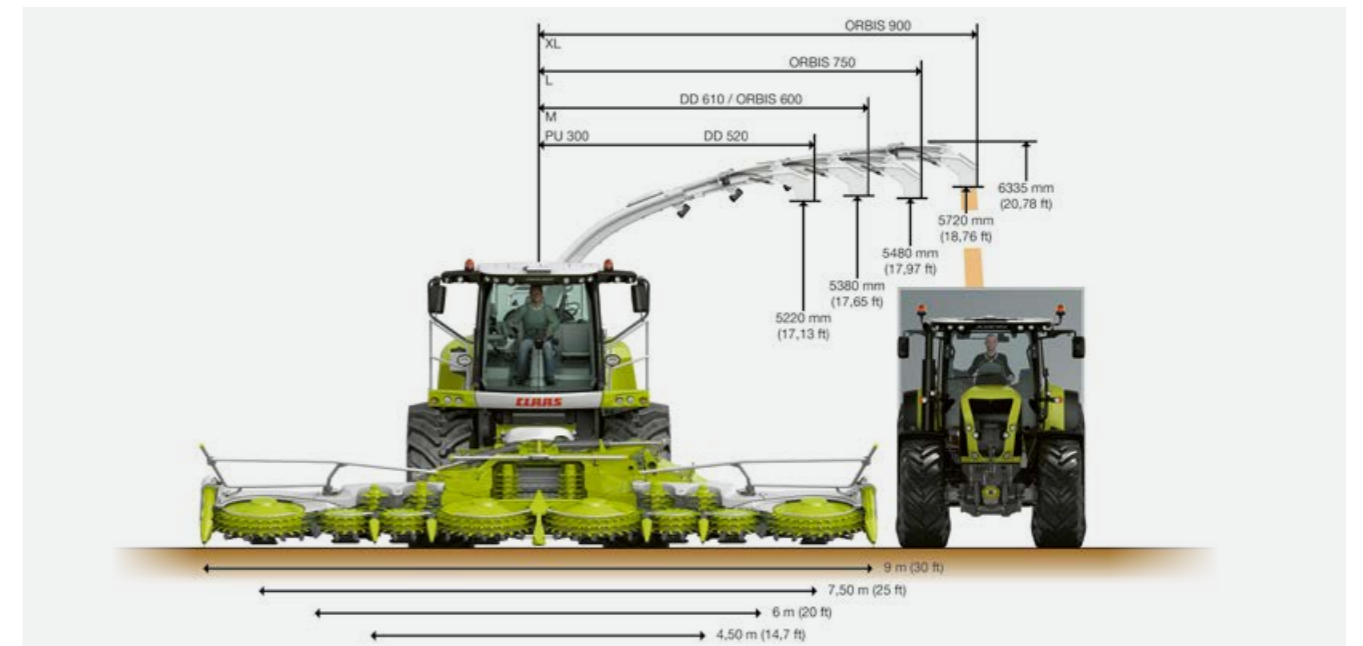

Low energy required for acceleration.

For heavy crops, the clearance between the accelerator and the rear wall can be increased hydraulically by up to 10 mm. This results in a huge reduction in the amount of energy required. If, for example, very dry grass requires a high discharge rate, a very narrow clearance setting can be set. This can even be set up in CEBIS while travelling and then applied automatically at the start of the chopping process.

The discharge spout. Modular design.

High strength and a low dead weight are the key characteristics of the discharge spout. The highly concentrated crop stream can be directed more reliably, minimising wasteful losses. The modular design enables the system to be adjusted to different working widths. Three extensions (M / L / XL) allow working widths of up to 9.0 metres. The back of the discharge spout is entirely bolted: as a result, the top plates also function as wear plates.

OPTI FILL: user-friendly.

The OPTI FILL optimised spout control system allows the discharge process to be managed extremely easily. The large swivel angle of up to 225° allows an optimal view of the discharge process. When the discharge spout is swivelled, the end flap is adjusted automatically so that the discharge process takes place parallel to the direction of travel. Two permanently programmed spout positions simplify the swivelling process at the end of the field, e.g. when chopping up and down along one edge of a field. Furthermore, the discharge spout can be returned to its parking position automatically at the touch of a button.



AUTO FILL.

Right on target – now also to the rear.



AUTO FILL. Automatic control of the discharge spout. Now also with rear discharging.

AUTO FILL is based on digital 3D image analysis. The system takes care of controlling the discharge spout for you. With AUTO FILL, discharging to the rear is now also automated.

In the past, the AUTO FILL function enabled automated discharging from the forage harvester to a trailer running alongside. With the new "Side Rear" AUTO FILL function, automated discharging from the forage harvester is now possible not only to the side but also to a trailer behind the forage harvester – perfect when starting chopping or dividing fields.

New – now also on 800-series JAGUAR models.

In chopping start-up mode, you can easily choose whether you wish discharging to take place to the side or the rear. For automatic filling to the rear, only the desired impact point needs to be specified.

For the AUTO FILL variant, the JAGUAR is equipped with LED swivelling spout lighting. This means that it is also possible to work in the dark while reducing the operator's workload.

The advantages at a glance.

- AUTO FILL: automatic filling of transport vehicles
- AUTO FILL with rear discharging

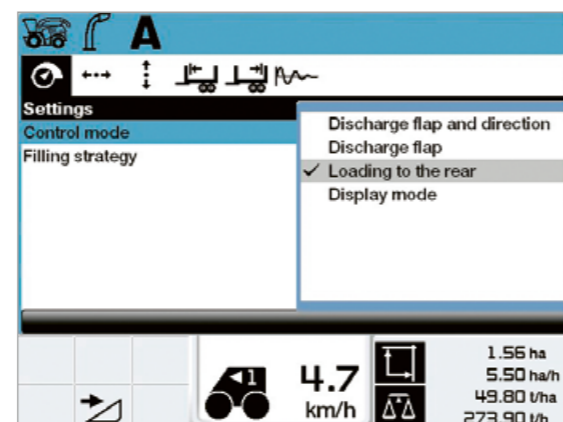

Throughput measurement. Precise data collection.

Throughput measurement with the QUANTIMETER.

The deflection of the upper rear precompression roller is recorded. On the basis of this data, together with the intake width and intake speed parameters, the volume flow is measured continuously.

In order to ensure the highest possible degree of accuracy (tonnes per hectare), counterweighing is necessary where there are differences in crop maturity or a change in variety.



The advantages at a glance.

- Throughput measurement with the QUANTIMETER
- Dry matter measurement with NIR sensor
- 375 l for conventional silage additive dosage
- ACTISILER 20 for concentrate dosage

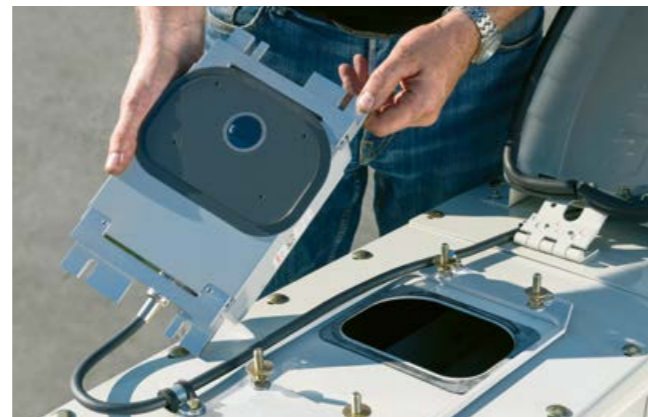

Dry matter measurement with NIR sensor.

Continuous dry matter measurement significantly improves the accuracy of the current throughput measurement.

The near infrared sensor (NIR sensor) operates at a very high frequency of 20 measurements per second. The alternative to this is costly and time-consuming laboratory testing (oven-drying method) of individual samples.

Additives for top-quality silage.

Applying silage additives while chopping has become one of the standard services offered by professional contractors. You can carry up to 375 l of fluid in the standard-fit additive tank which is easy to fill. The mixed additive is sprayed straight into the crop accelerator.

- Tank capacity of 375 l
- Flexible filling and cleaning facility
- Dosage from 30 l/h to 400 l/h
- Throughput based dosage from 0.5 l/t to 2 l/t (up to 200 t/h)
- Dosage on basis of dry matter possible
- Sight tube for external level indication

The dosage is controlled via CEBIS. Furthermore, the system informs the driver about the fill level of the tanks.



ACTISILER 20 for precise dosage.

There is currently a trend towards a reduced quantity and a higher concentration. The new, optional ACTISILER 20 has been designed specifically to achieve this high-precision task with a precisely dosed quantity of concentrated lactic acid bacteria solution. The control of the dosage, the record of how much you apply and the monitoring functions are all easily managed using CEBIS.

- Separate 20 l tank for highly concentrated lactic acid solution
- Dosage is controlled via CEBIS:
 - constant: 200 ml/h to 7500 ml/h;
 - throughput-based: 10 ml/t to 30 ml/t
- Dosage on basis of dry matter possible

Both systems can also be used simultaneously.



Additive tank with capacity of up to 375 l.

The JAGUAR front attachments. Effective and durable.

- Swath collection with the PICK UP
- Whole-plant cutting with the DIRECT DISC
- Maize harvesting with the ORBIS or RU
- Maize picking with the CORIO

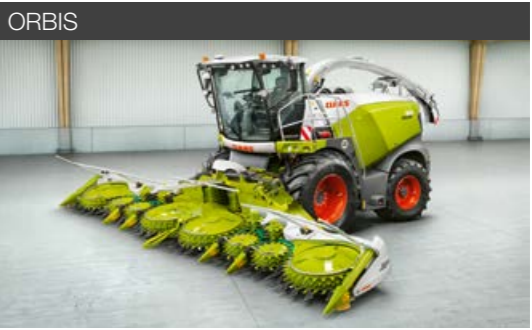
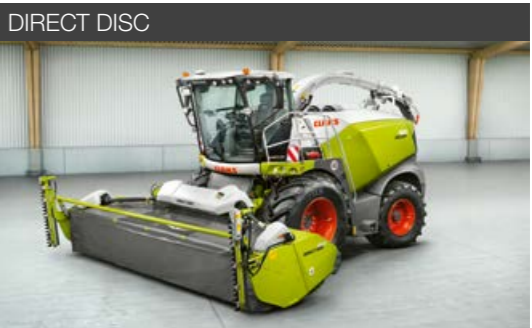

PICK UP. A thorough job, perfectly controlled.

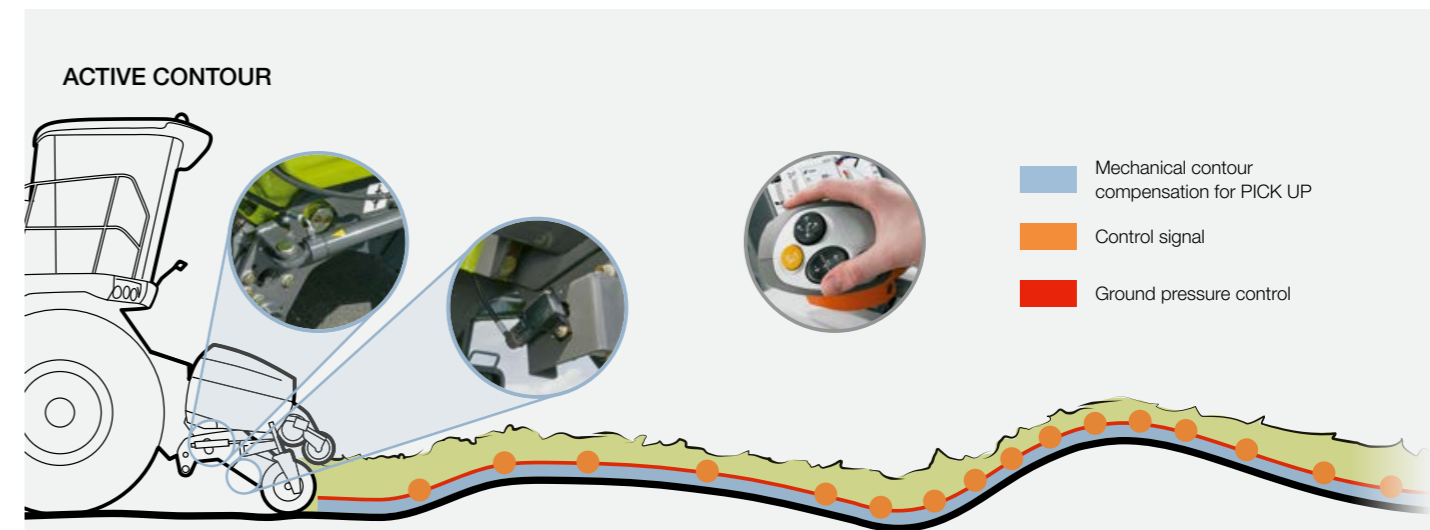
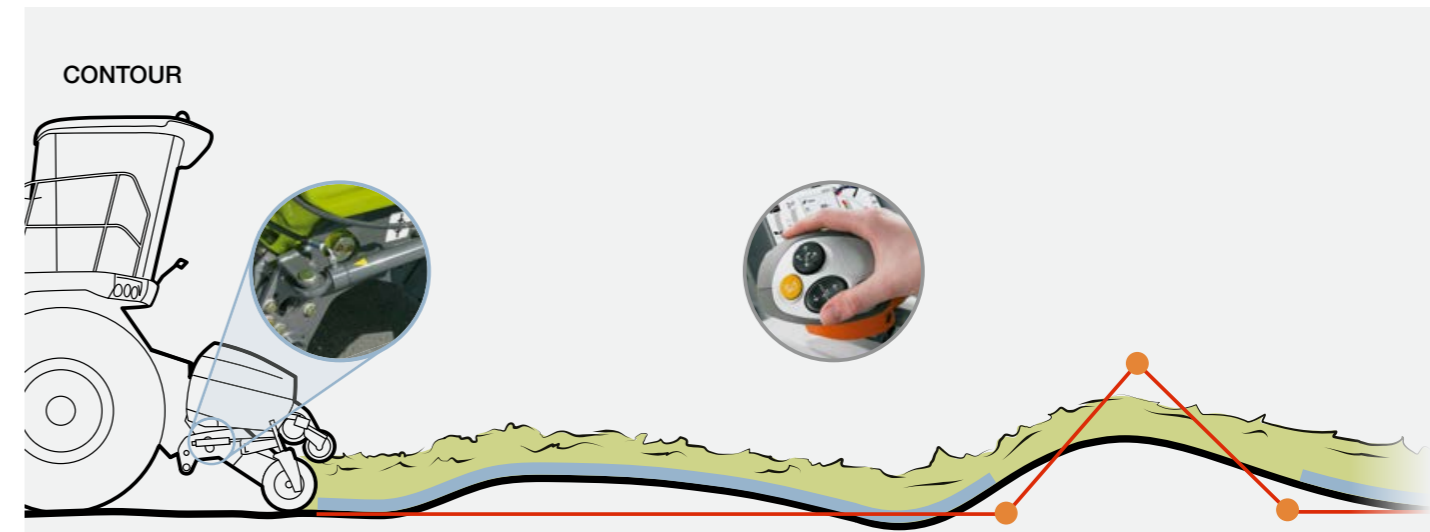

PICK UP. Crop flow adjustment.

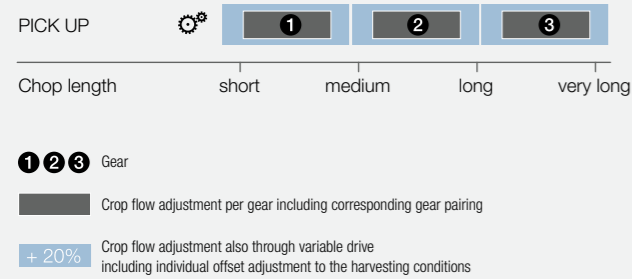

NEW: PICK UP 380 and 300.
Robust and flexible.

The trend towards ever more powerful forage harvesters and higher yields means that requirements such as clean crop intake, robust technology and straightforward operation are becoming ever more important.

The advantages at a glance.

- High-performance rake with five rows of tines for clean crop intake
- Optimal ground-contour following through suspended frame
- Rapid adaptation to changing ground contours with ACTIVE CONTOUR



A family with details that make all the difference:

- Attachments can be easily attached and removed by quick-connect coupler and central locking lever on the left-hand side
- Rake designed for high performance with five rows of tines for clean crop intake
- Robust roller crop press close to intake auger for even crop flow
- Large auger diameter designed for optimal crop transfer even at high throughput
- Ideal ground-contour following through suspended frame for both model series
- Folding caster guide tools whose height can be adjusted without tools for ease of use
- Wear parts can be replaced easily after being subjected to extreme wear

- Rugged drive line with protection for rake and intake auger and user-friendly 3-speed gearbox
- The optional variable drive of the JAGUAR 900-series ensures that the speed of the intake auger is automatically matched ideally to the set chop length
- ACTIVE CONTOUR ensures that the height control system reacts very quickly to uneven ground

DIRECT DISC.

Mowing, chopping, harvesting. Job done.



DIRECT DISC 600 / 500.



Suitable for crop heights of up to 4.0 m (sorghum), with large intake auger

NEW: DIRECT DISC 600 P / 500 P.



Suitable for short to medium crop heights (legumes, grains), with additional paddle roller

Whole-plant cutting with the DIRECT DISC.

Whether you are intending to use milk ripe plants for high-grade animal feed or as biomass for energy production, this front attachment means you can mow and chop in a single pass.

The DIRECT DISC cuts the crop with the MAX CUT mowing bar. The mowing discs, which are positioned well forward, produce very even stubble. Harvesting very short to medium height crops with the DIRECT DISC 500 P and 600 P is facilitated by an additional paddle roller which is adjustable for height. This has the advantage of ensuring a reliable crop flow from the mowing bar to the intake auger, especially when harvesting short crops such as legumes.

The DIRECT DISC 500 and 600 models without a paddle roller are designed for use in medium height and tall crops. In this way it is possible to attain high harvest yields and handle crop heights of up to 4.0 m.

CLAAS offers side knives for both model series. These are extremely helpful when harvesting severely intertwined crops, such as vetch-rye or sorghum.

Simple, convenient, variable.

- Simply couple and lock with the quick coupling
- Delayed activation of paddle, auger and the mower unit means that DIRECT DISC can also be used under full load
- Three different speeds of paddle and auger for a smooth crop flow and optimal chopping quality
- Proven DISCO mowing bar for high chopping output and neat work quality.
- Reduced downtime, thanks to quick blade change
- Perfect adaptation to harvesting conditions with hydraulically height-adjustable paddle roller
- Easy access to conveying elements through large service opening
- Excellent ground adaptation through mechanical lateral balance and skid-assisted guidance with ground pressure control
- Side knives optionally available



Powerful drives with optimal protection



Side knives for DIRECT DISC 600 / 500



Quick knife change

ORBIS. Smooth-running and variable.



ORBIS. Row-independent harvesting.

The ORBIS row-independent maize header combines experience gained in practical use all over the world with innovative ideas relating to the design and drive.

The optional variable drive of the JAGUAR ensures that the speed of the intake auger is automatically matched ideally to the set chop length. Furthermore, the speed can be set manually for different harvesting conditions.

- Quick coupler enables easy frictional connection with JAGUAR
- Working widths of 4.50 m, 6.00 m, 7.50 m or 9.00 m
- Optimal crop flow: consistent chopping quality depends on a longitudinal plant feed
- Light-running drive: low starting torque and low power requirement, so that it can be engaged and reversed under power
- Additional equipment variants for ideal matching to different harvest conditions
- Optimal ground contour following: suspended-frame geometry for ideal lateral balance optionally available with AUTO CONTOUR

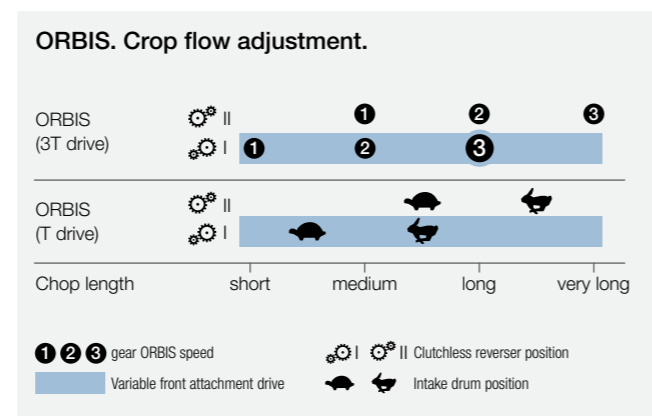
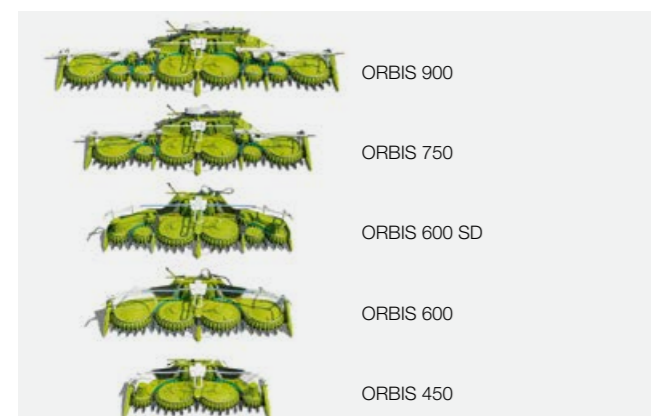

The ORBIS 600 SD is offered in parallel to the ORBIS 600 and is particularly suited to normal and low-growing stands. The outer sections with the small discs and the additional vertical feed drums enable an extremely good crop flow. It is also possible to cut the stubble extremely close. The ORBIS 600 with the large discs comes into its own in normal and very high yield maize stands.



Integrated transport system.

During road travel, the running gear integrated in ORBIS is deployed. The hydraulic rams are actuated actively. The vibration damping allows comfortable and safe road travel at up to 40 km/h.

During field work, the running gear is deactivated and retracted into the parking position.



Integrated transport system



AUTO CONTOUR, ground pressure control with lateral levelling

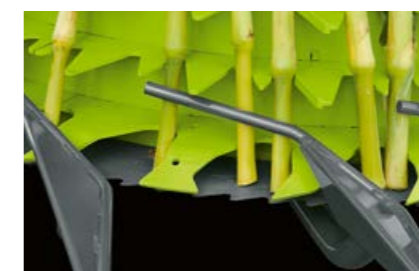

Gentle crop transport and self-sharpening effect



Optional: practical support for carrying the front attachment protection element during harvesting

RU 450.

Proven in countless deployments.



RU 450: up to 4.50 m working width.

The crop flow concept is based on three large cutting and transport discs rotating counterdirectionally to each other. The cut surfaces of the plants rest on the blade and create a self-sharpening effect as they are fed in.

An aggressive crop flow is ensured by the intake auger whose speed can be optimised in line with the set chopping length. The simple construction makes for ruggedness and reliability and has proven itself extremely well.

- Low power requirement
- Reliable crop transport under all conditions
- Can be switched on and reversed under full load
- Adapts easily with quick coupler

The advantages at a glance.

- RU 450 with three large cutting and transport discs
- Counterdirectional rotation of the knife discs
- Self-sharpening effect



CORIO easily adapted. 6 or 8-row maize picking.

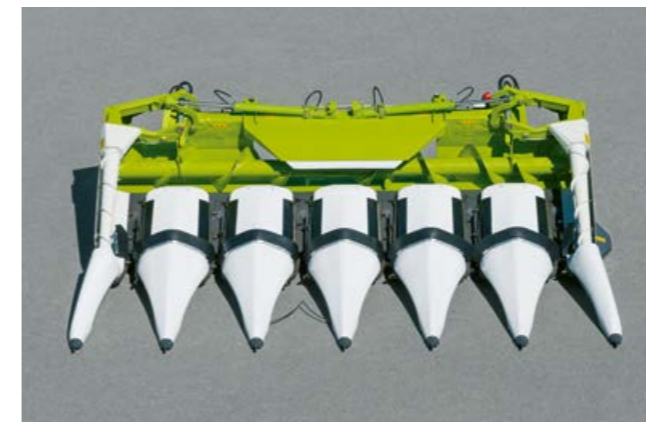

Maize cob silage (MCS).

MCS is forage with a high energy concentration and is primarily used in cattle farming for milk and meat production.

Possible corncracker variants as recommended equipment for high-quality silage production when harvesting whole crop silage (wcs) or maize cob silage (mcs):

- MULTI CROP CRACKER CLASSIC with very fine tooth system and 60% speed differential
- MULTI CROP CRACKER MAX



Adapter allowing combine harvester front attachments to be used on forage harvester.

The adapter makes it possible to use a maize picker with a working width of up to 6.0 m, e.g. the CORIO 875. Power transmission from the JAGUAR to the adapter takes place via the quick coupling.



The advantages at a glance.

- Maize cob silage (MCS): harvesting with a maize picker on the JAGUAR.
- CLAAS adapter



Maize cob silage



MCC CLASSIC 150 / 150 speed differential 60%



MCC MAX for particularly intensive processing



Quick coupling adaptation for maize pickers

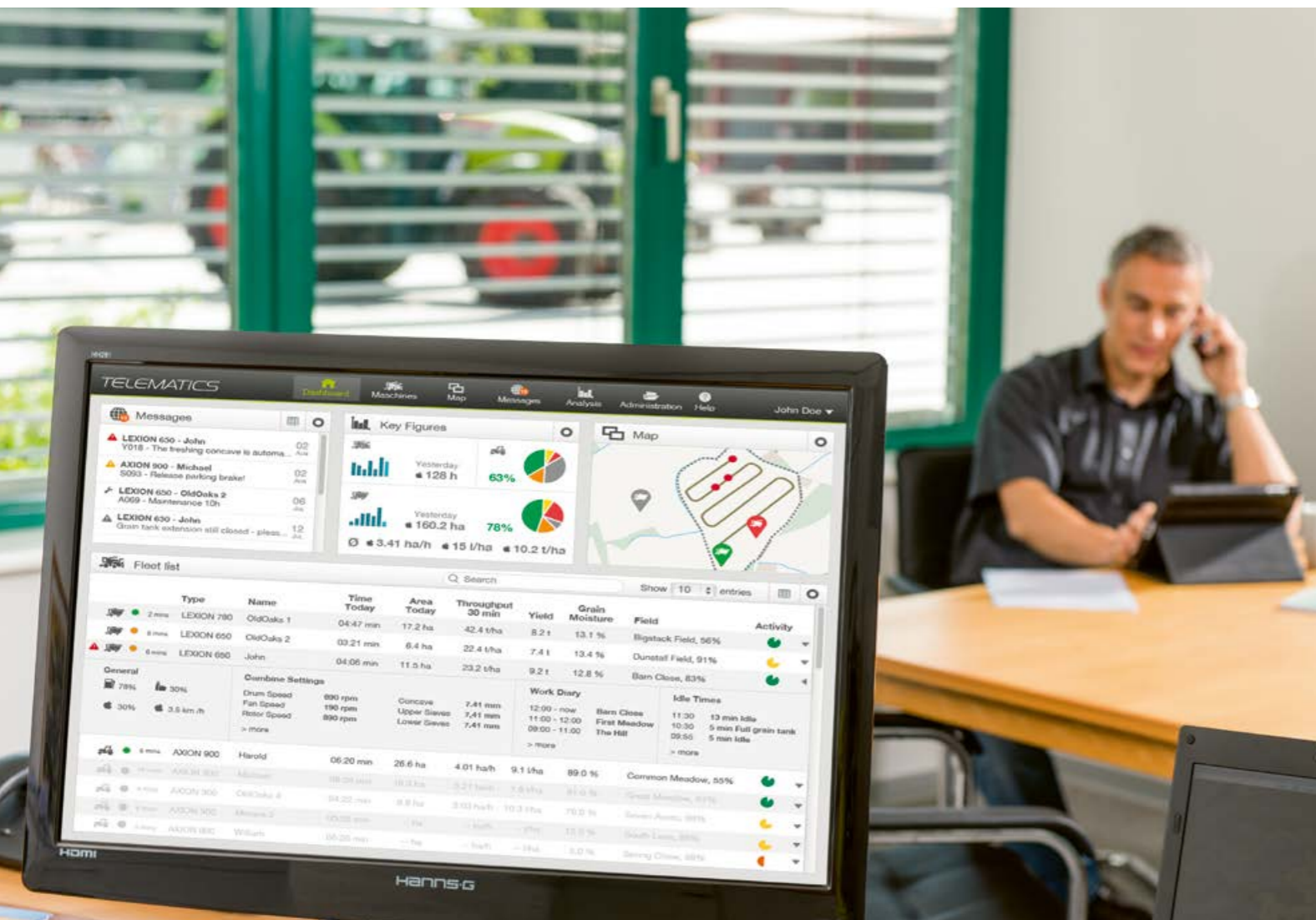

A complete overview with just a click of the mouse.

With TELEMATICS, CLAAS lets you retrieve all of your important machine data via the Internet, anytime, anywhere – so why not benefit from TELEMATICS yourself?

All information by email to optimise the fleet.

A report detailing the operating hours analysis and other important analyses is sent to you daily by email. This enables you to analyse the precise data from the previous day before starting work, and to determine when and how efficiently your machine has been operating. Additionally, movement data based on vehicle tracks can be retrieved with the event log, thereby enhancing transport logistics. TELEMATICS facilitates systematic fleet management and avoids unprofitable downtime.

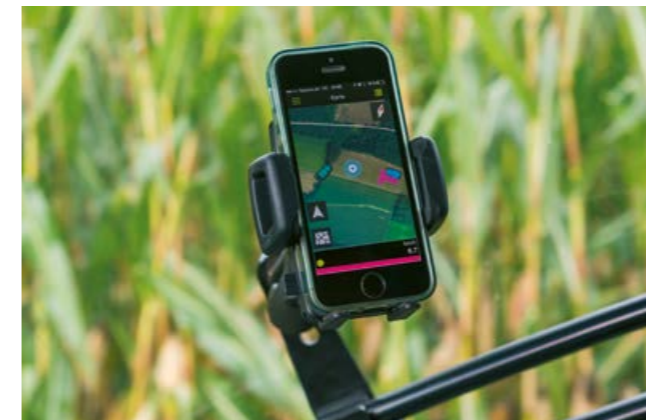

NEW: Fleet View App.

In Fleet View, CLAAS has created an app which allows a harvesting chain to keep on working without idle time. The app continuously informs all the operators/drivers about the position of the forage harvester and the trailers.

- Trailer drivers can choose the optimal field entrance and avoid unnecessary detours.
- Trailer drivers can see if the forage harvester is idle or harvesting
- Trailer drivers can spot oncoming trailers and take the necessary action to avoid them
- The forage harvester operator can anticipate waiting times and use these for knife sharpening, for example

Automatic documentation.

This function documents and processes the process data automatically. As an extension to TELEMATICS, the automatic documentation system transfers the job data relating to the specific field deployment – without any intervention by the machine operator – to the server where they are interpreted and processed. This is carried out on the basis of the field boundaries previously uploaded from your system. Further processing is straightforward, as all machine-relevant data can be exported in ISO-XML format.

Faster service. CLAAS remote diagnostics.

With your consent, TELEMATICS can transmit maintenance and repair data to your CLAAS sales partner. This enables your CLAAS partner to carry out an initial analysis via CDS REMOTE – when required – to find the causes of faults more quickly and to make optimum preparations to assist you on site as quickly as possible.

Yield data optimisation through weighbridge.

The data from a weighbridge can be uploaded via TELEMATICS. These data are then used to correct the yield data automatically via TELEMATICS.



Automatic documentation



Weighbridge

Data management. Modular and of immediate use.



Data management.

1. Job management, standard

It is possible to create a collection of 20 jobs in CEBIS. As a result, all the relevant data are available to you at all times and you also have the option of printing them out.

2. Job management (initial expansion stage)

AGROCOM MAP START software allows you to manage data relating to specific customers and jobs and then transfer these to your PC by means of a Compact Flash Card. Furthermore, TELEMATICS allows you to monitor the job in question online.

3. Job management (second expansion stage): yield mapping

Using the job management functions as a basis, you can perform yield mapping with your JAGUAR. The QUANTIMETER and the moisture measurement function allow the yield to be determined while CEBIS adds geographic coordinates using GPS satellite data. All measurements are stored on portable chip cards to facilitate transfer. With the AGROCOM MAP START software, you can produce informative yield maps to use as a basis for your future production strategy.

CEBIS. Evaluate and make use of current data.

You can prepare customer data in CEBIS before running and processing them with CEBIS.

- All the data are backed up when a specific job is completed or the working day comes to an end
- The data can be printed out selectively or transferred by data card for job processing
- With TELEMATICS, the data can also be accessed online with a PC and can be reused, e.g. for customer invoicing

The advantages at a glance.

- CEBIS: benefit immediately from current data.
- Job management in three stages



The guidance systems. Precisely the help you need.



Seeing with CAM PILOT.

The CAM PILOT assumes control of steering the JAGUAR in combination with the PICK UP. The swath is detected as a three-dimensional image by a twin-lens camera. Corresponding signals are transmitted to the steering mechanism in the event of deviations in the swath shape or direction. The steering axle then responds to these steering commands. This makes for a reduced operator workload at speeds up to 15 km/h.



Guidance by GPS PILOT.

GPS PILOT uses a satellite signal to guide the JAGUAR reliably in parallel paths or along curved contours defined by the crop edge. The system allows the operator to use the full working width while reducing overlapping to a significant degree.



Sensing with AUTO PILOT.

During the harvesting process, maize is usually followed in rows, even with row-independent maize front attachments. Two sensor arms each gauge a row of maize. The signals generated by these sensors are translated into corrective steering impulses. Twin-row sensing allows automatic guidance in row widths from 37.5 cm up to 80 cm.

The advantages at a glance.

- CAM PILOT: the JAGUAR is guided by the PICK UP
- GPS PILOT: guidance by satellite signal
- AUTO PILOT: automatic guidance based on row widths

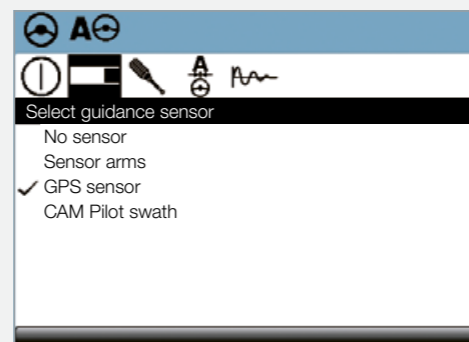

PREMIUM LINE.

Extra-hard, highly wear-resistant.

Now also available ex factory.

For demanding harvesting conditions PREMIUM LINE offers specially coated and highly wear-resistant parts. The extremely long service life of these parts increases their operating hours significantly. And that saves you time and money.



- 1 Feed roller wear bars
- 2 Wear plate, at right and left at front of intake
- 3 Wear plate, at right and left at rear of intake
- 4 Drum roller stripper bar
- 5 Drum concave
- 6 Vanes
- 7 Grass chute rear wall
- 8 Corncracker rollers
- 9 Accelerator paddles
- 10 Accelerator housing, two-part
- 11 Accelerator housing, left / right sides
- 12 Accelerator rear wall
- 13 Discharge tower plates, front / rear
- 14 Spout rotation assy.
- 15 All spout wear plates

Wear reduced. Low maintenance.
High reliability.

PREMIUM LINE protection against wear.

- 1 PREMIUM LINE crop flow: a special wear coating gives feed drums low wear characteristics. Welded interior guide strips made from HARDOX. Exterior guide strips made of steel. Additional wear elements to protect the large cutting discs and knives.
- 2 PREMIUM LINE skids: additional skids as protection against wear.

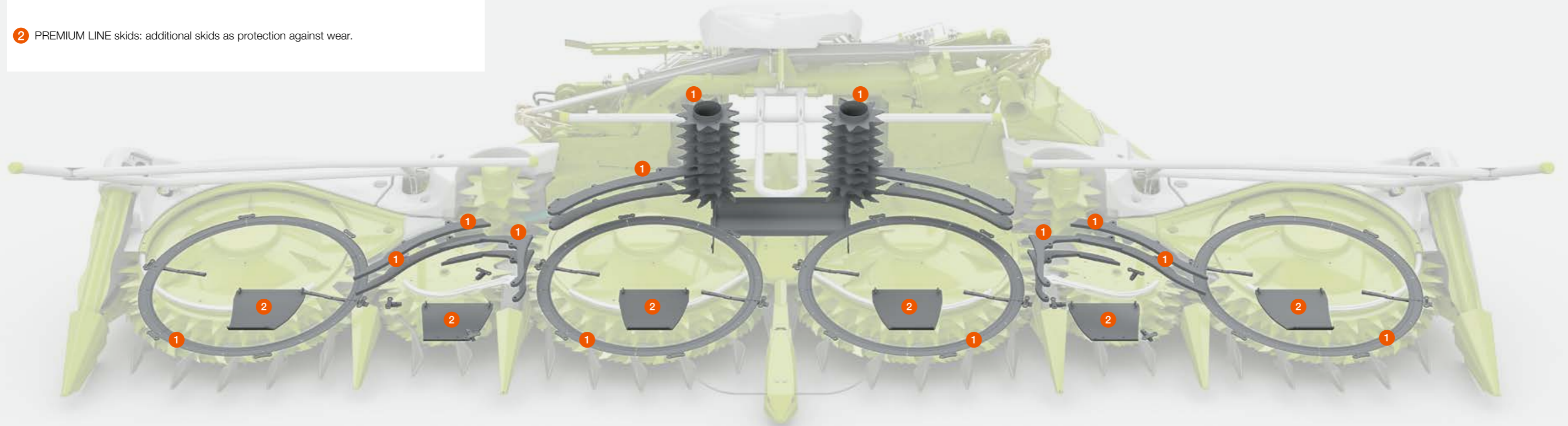

PREMIUM LINE for ORBIS.

Highly wear-resistant parts are recommended for extreme operating conditions, where there is a high proportion of sand, for example, or extended periods of operation.

High operational reliability.

It is often the case that every minute counts during the forage harvesting period. Time-consuming maintenance work is a nuisance and also a cost factor, since it reduces the number of productive hours – and also your profit margin.

With ORBIS, wear-resistant parts ensure high long-term reliability:

- The knives have a tungsten carbide coating to increase their service life
- The speed difference between the knife disc and the transport disc creates a self-sharpening action
- The knife discs and transport discs have a modular structure comprising six segments and are easily accessible; as a result, in the event of damage, only the segment concerned needs to be replaced, rather than the entire unit

Extremely maintenance-friendly design.

CLAAS engineers have done all they can to keep maintenance requirements to a minimum.

- Lubrication is only required every 250 operating hours
- All lubrication points are easily accessible
- A transmission oil change is only required after 1000 operating hours
- All wear parts can be replaced quickly and easily



The maintenance concept. Quick and straightforward.

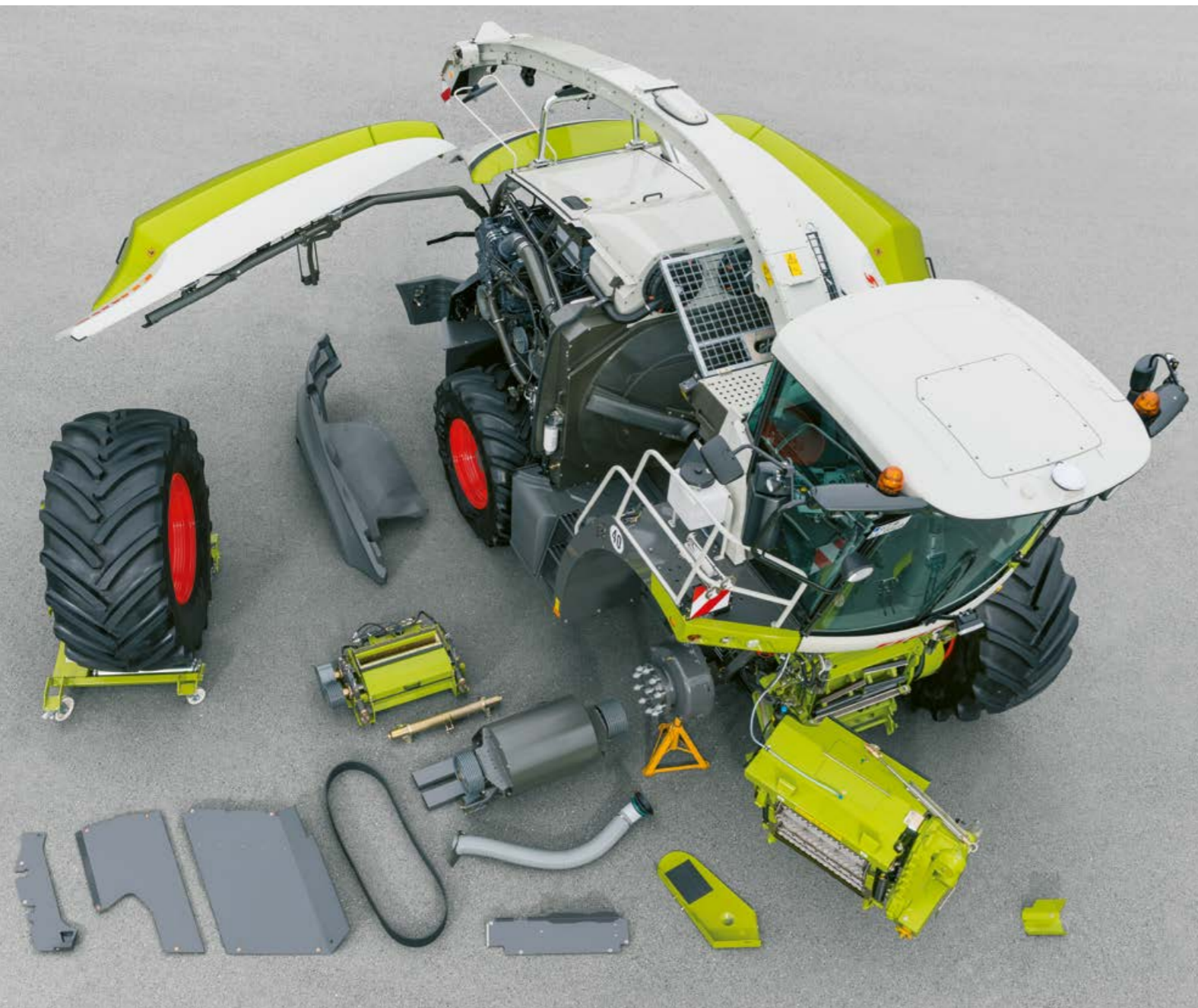

The advantages at a glance.

- Numerous work lights turn night into day
- QUICK ACCESS: quick inspection of chopping unit
- Maintenance-free brake system
- Long-life hydraulic oil



Seat contact switch: front attachment and main drive are switched off automatically



LED step lighting



QUICK ACCESS



16 l supply of grease



Two-stage opening of side panel



Easy access



Quick removal of accelerator



Long-life hydraulic oil

Save time, energy and trouble.

- Seat contact switch for safety: leaving the operator's seat causes the front attachment and main drive to be switched off after 7 seconds
- Work lights under side and rear panels as well as in stowage compartment for a clear view
- Hand lamp with magnetic base for front illumination
- Afterglow function for work lights after ignition is switched off
- Steps illuminated to allow safe exit from cab in the dark too
- QUICK ACCESS lets you inspect the chopping unit in a matter of minutes
- The spacious storage compartment ensures that all tools and accessories are within easy reach
- 16 litre supply of grease where automatic central lubrication is fitted, sufficient for about 280 hours of operation with Corncracker (approx. 500 operating hours without Corncracker fitted)
- Filled as standard with Shell Alvania RL3 / K3 high-performance antifriction bearing grease for very high temperature stability, low friction losses and a long service life
- Large side panels with two opening height detents for shorter or taller staff allow unrestricted access to the cooling system, the corncracker and the accelerator
- Intake air filter can be accessed very easily in the dust-free zone, maximised service intervals
- Maintenance-free brake system
- If maintenance is required, the accelerator can be removed by two people in the space of one hour
- Optional: biodegradable hydraulic oil, AGRHYD XTREME 46 long-life hydraulic oil. The standard oil change interval increases from 1000 hours to at least 3000 h. The oil is notable for its short warm-up time, very high temperature stability, optimal lubrication characteristics and extremely high viscosity.

Whatever it takes. CLAAS Service & Parts.



Your requirements count.

You can always rely on us: we'll be there whenever you need us – everywhere, quickly and reliably, around the clock if necessary, with precisely the solution that your machine or business requires. Whatever it takes.

ORIGINAL parts and accessories.

Specially matched to your machine: precision-manufactured parts, high-quality consumables and useful accessories. We will supply exactly the right solution from our comprehensive product range to ensure that your machine is 100% reliable. Whatever it takes.

For your business: CLAAS FARM PARTS.

CLAAS FARM PARTS offers one of the most comprehensive ranges of parts, regardless of brand and sector, for all agricultural applications on your farm. Whatever it takes.

Always up to date.

CLAAS dealers are among the most efficient agricultural technology companies in the world. Our service teams are ideally qualified and equipped with the all-important special tools and diagnostic systems. CLAAS Service stands for high-quality work which meets all your expectations with regard to expertise and reliability. Whatever it takes.

Reliability can be planned.

With our service products, you can increase your machine reliability, minimise your risk of breakdowns, and budget with confidence. CLAAS MAXI CARE offers planned reliability for your machine. Whatever it takes.

Worldwide coverage from Hamm.

Our central spare parts warehouse delivers all ORIGINAL parts quickly and reliably all over the world. Your local CLAAS partner can supply the right solution for your harvest or your business within a very short time. Whatever it takes.

Problem solving by remote diagnostics: CLAAS TELEMATICS.

CLAAS TELEMATICS on your machine brings two important advantages: fast assistance from CLAAS service technicians and a more profitable operation, thanks to wireless networking. We can be there, on the spot, to solve your problem – even when you can't see us. Whatever it takes.

The CLAAS Parts Logistics Center in Hamm, Germany, stocks more than 155,000 different parts in a warehouse area of over 100,000 m².



More attractive pricing with the equipment package.

To make it easier for you to choose between particular items of optional equipment, we offer an equipment package for our JAGUAR models. Our experts have put this package together on the basis of our customers' requirements.

You benefit from a set of components which complement each other ideally and from the attractive pricing. Contact your distributor for information about availability.

NIR package:

- QUANTIMETER for throughput measurement
- Chop length automatically set on basis of dry matter
- NIR sensor to measure dry matter

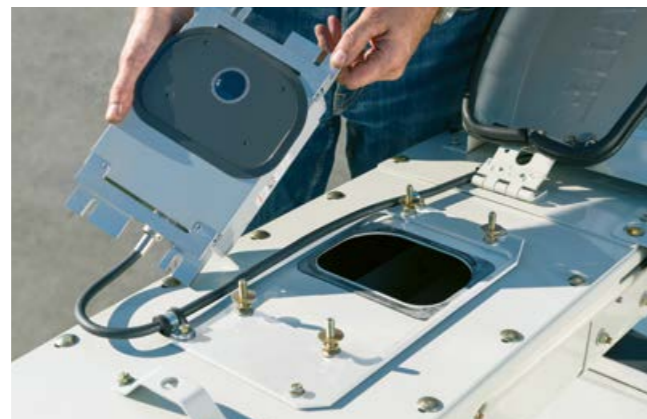
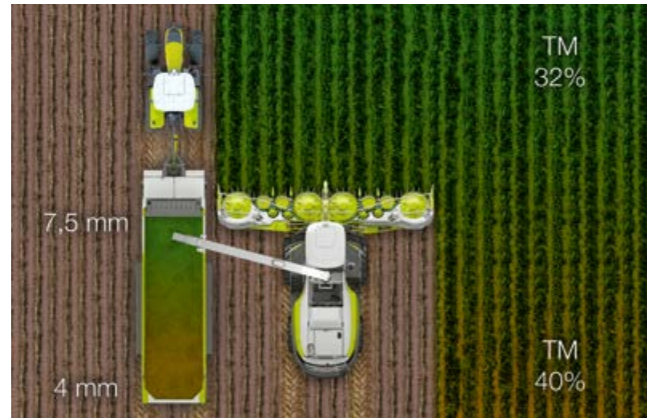

JAGUAR		980	970	960	950	940	930
Engine							
Manufacturer		MAN	MAN	Mercedes-Benz	Mercedes-Benz	Mercedes-Benz	Mercedes-Benz
Type		D2862	D2868	OM 473 LA	OM 473 LA	OM 471 LA	OM 471 LA
Cylinders		V12	V8	S6	S6	S6	S6
Displacement	l	24.24	16.16	15.60	15.60	12.80	12.80
Engine output at working speed of 1700 rpm (ECE R 120)	kW/hp	650/884 ¹	570/775 ¹	460/626	430/585	380/516	340/462
Fuel tank with auxiliary tank	l	1200 + 300 ¹	1200 + 300 ¹	1050 + 300	1050 + 300	1050 + 300	1050 + 300
Urea tank	l	- ¹	- ¹	130	130	130	130
Fuel consumption measurement		o	o	o	o	o	o
DYNAMIC POWER		o	o	o	o	o	-
Running gear							
Traction drive: 2-speed OVERDRIVE transmission, automatic (hydrostatic)		●	●	●	●	●	●
Differential lock		o	o	o	o	o	o
Tyre pressure adjustment system – drive axle		o	o	o	o	o	o
Tyre pressure adjustment system – drive and steering axle		o	o	o	o	o	o
Steering axle, standard		o	o	o	o	o	o
Steering axle, 3 x adjustment, 2510, 2970, 3130 mm		o	o	o	o	o	o
POWER TRAC driven steering axle		o	o	o	o	o	o
Water / silage additive tank content, 375 l		●	●	●	●	●	●
ACTISILER 20 content, highly concentrated, 20 l	l	o	o	o	o	o	o
Front attachments							
Maize front attachment ORBIS, RU (rows / width)	r/m	12 / 9, 10 / 7.5, 8 / 6	12 / 9, 10 / 7.5, 8 / 6	12 / 9, 10 / 7.5, 8 / 6	10 / 7.5, 8 / 6, 6 / 4.5	10 / 7.5, 8 / 6, 6 / 4.5	8 / 6, 6 / 4.5
PICK UP 380, 300, working width 3600, 2620 mm		o	o	o	o	o	o
DIRECT DISC 600 P, 500 P, working width 5960 / 5130 mm		o	o	o	o	o	o
DIRECT DISC 600/500, working width 5960, 5130 mm		o	o	o	o	o	o
Front attachment drive							
Standard		●	●	●	●	●	●
Split-power		o	o	o	o	o	o
Variable		o	o	o	o	o	o
Intake							
Width, 730 mm		●	●	●	●	●	●
Intake and precompression rollers, no. 4		●	●	●	●	●	●
Hydraulic precompression		o	o	o	o	o	o
COMFORT CUT chop length adjustment, infinitely variable		●	●	●	●	●	●
Chopping cylinder							
Width, 750 mm		●	●	●	●	●	●
Diameter, 630 mm		●	●	●	●	●	●
Knife configuration							
V20 / 2 x 10		o	o	o	o	o	o
V10 / 2 x 5							
V24 / 2 x 12		o	o	o	o	o	o
V12 / 2 x 6							
V28 / 2 x 14		o	o	o	o	o	o
V14 / 2 x 7							
V36 / 2 x 18		o	o	o	o	o	o
V18 / 2 x 9							
V12 / 2 x 6							
Automatic knife sharpening from cab		●	●	●	●	●	●
Shear bar adjusted automatically from the cab		●	●	●	●	●	●
MULTI CROP CRACKER							
MCC CLASSIC, M, ø 196 mm		-	-	o	o	o	o
MCC CLASSIC, L, ø 250 mm		o	o	o	o	o	-
MCC MAX, ø 265 mm		o	o	o	o	o	-
MCC SHREDLAGE®, M, ø 196 mm		-	-	o	o	o	o
MCC SHREDLAGE®, L, ø 250 mm		o	o	o	o	o	-

¹ As the engine output is greater than 560 kW, the JAGUAR 980 and 970 models are not subject to any emission regulations.

JAGUAR		980	970	960	950	940	930
Crop accelerator							
Width 680 mm		●	●	●	●	●	●
Diameter 540 mm		●	●	●	●	●	●
Gap setting 2-10 mm		o	o	o	o	o	o
Discharge spout							
Breakback protection		●	●	●	●	●	●
Swivel angle, standard, 210°		●	●	●	●	●	●
Swivel angle with OPTI FILL / AUTO FILL, 225°		o	o	o	o	o	o
Discharge spout S (up to DD 250)		●	●	●	●	●	●
Extension M (ORBIS 600), 1 x 750 mm		o	o	o	o	o	o
Extension L (ORBIS 750), 2 x 750 mm		o	o	o	o	o	o
Extension XL (ORBIS 900), 3 x 750 mm		o	o	o	o	o	o
EASY							
OPTI FILL, optimised spout control		o	o	o	o	o	o
AUTO FILL, automatic trailer filling		o	o	o	o	o	o
STOP ROCK stone detector		o	o	o	o	o	o
QUANTIMETER throughput measurement		o	o	o	o	o	o
QUANTIMETER + continuous moisture measurement		o	o	o	o	o	o
Job management		o	o	o	o	o	o
Yield mapping		o	o	o	o	o	o
TELEMATICS		●	●	●	●	●	●
AUTO PILOT central sensors (maize)		o	o	o	o	o	o
CAM PILOT swath recognition (grass)		o	o	o	o	o	o
GPS PILOT		o	o	o	o	o	o
CRUISE PILOT		●	●	●	●	●	●
Maintenance							
Central lubrication, 16-l grease reservoir		o	o	o	o	o	o
Service lighting		o	o	o	o	o	o
VISTA CAB							
A / C MATIC air conditioning		o	o	o	o	o	o
CEBIS colour monitor		●	●	●	●	●	●
Printer		o	o	o	o	o	o
Comfort seat		o	o	o	o	o	o
Swivelling seat		o	o	o	o	o	o
Premium seat, ventilated, heated		o	o	o	o	o	o
Leather seat, ventilated, heated		o	o	o	o	o	o
Passenger seat		o	o	o	o	o	o
VISTA CAB							
Working length	mm	6495	6495	6495	6495	6495	6495
Working height with discharge spout extension XL	mm	6335	6335	6335	6335	6335	6335
Transport height	mm	3945	3945	3945	3945	3945	3945
Transport length with discharge spout extension XL	mm	8590	8590	8590	8590	8590	8590
Weight on standard tyres without front attachment	kg	13800	13400	13150	13150	12750	12750

CLAAS continually develops its products to meet customer requirements. This means that all products are subject to change without notice. All descriptions and specifications in this brochure should be considered approximate and may include optional equipment that is not part of the standard specifications. This brochure is designed for worldwide use. Please refer to your nearest CLAAS dealer and their price list for local specification details. Some protective panels may have been removed for photographic purposes in order to present the function clearly. To avoid any risk of danger, never remove these protective panels yourself. In this respect, please refer to the relevant instructions in the operator's manual. All technical specifications relating to engines are based on the European emission regulation standards: Stage. Any reference to the Tier standards in this document is intended solely for information purposes and ease of understanding. It does not imply approval for regions in which emissions are regulated by Tier.

JAGUAR		980	970	960	950	940	930
Tyres							
Drive axle, transport width acc. to tyre size up to 1950 mm diam.							
IF 680/85 R 32 179 A8	mm	3107	3107	3107	3107	3107	3107
IF 680/85 R32 179 A8	mm	3667	3667	3667	3667	3667	3667
710/70 R 38 171 D	mm	3209	3209	3209	3209	3209	3209
710/70 R 38 171	mm	3201	3201	3201	3201	3201	3201
710/70 R 38 175	mm	3201	3201	3201	3201	3201	3201
710/75 R 34 178 A8	mm	3185	3185	3185	3185	3185	3185
710/75 R 34 178 A8	mm	3205	3205	3205	3205	3205	3205
800/70 R 32 175 A8	mm	3287	3287	3287	3287	3287	3287
800/70 R 32 181 A8 MI	mm	3286	3286	3286	3286	3286	3286
IF 800/70 R 32 182 A8 MI	mm	3287	3287	3287	3287	3287	3287
IF 800/70 R 32 182 A8	mm	3381	3381	3381	3381	3381	3381
900/60 R 32 176 A8	mm	3455	3455	3455	3455	3455	3455
900/60 R 32 176 A8 MI	mm	3465	3465	3465	3465	3465	3465
900/60 R 32 176 A8 TR	mm	3455	3455	3455	3455	3455	3455
Drive axle, transport width acc. to tyre size up to 2050 mm diam.							
680/80 R 38	mm	2985	2985	2985	2985	2985	2985
IF 800/70 R 38	mm	3286	3286	3286	3286	3286	3286
IF 800/70 R 38	mm	3380	3380	3380	3380	3380	3380
IF 900/60 R 38	mm	3495	3495	3495	3495	3495	3495
710/70 R 42	mm	3201	3201	3201	3201	3201	3201
800/70 R 38	mm	3286	3286	3286	3286	3286	3286
800/70 R 38	mm	3380	3380	3380	3380	3380	3380
(für erweiterte Maschinenbreite)							
900/60 R 38 178 D	mm	3496	3496	3496	3496	3496	3496
Steering axle, transport width by tyre size							
500/85 R 30	mm	2917	2917	2917	2917	2917	2917
540/65 R 28	mm	2960	2960	2960	2960	2960	2960
540/65 R 30	mm	2960	2960	2960	2960	2960	2960
540/65 R 34	mm	2960	2960	2960	2960	2960	2960
600/65 R 28	mm	3045	3045	3045	3045	3045	3045
600/65 R 28	mm	3021	3021	3021	3021	3021	3021
600/65 R 28 IMP	mm	3020	3020	3020	3020	3020	3020
600/65 R 28 TR	mm	3020	3020	3020	3020	3020	3020
620/70 R 30	mm	3080	3080	3080	3080	3080	3080
VF 620/70 R 26	mm	3045	3045	3045	3045	3045	3045
VF 620/70 R 30	mm	3040	3040	3040	3040	3040	3040
620/70 R 30	mm	3080	3080	3080	3080	3080	3080



Ensuring a better **harvest.**

CLAAS KGaA mbH
Mühlenwinkel 1
33428 Harsewinkel
Deutschland
Tel. +49 5247 12-0
claas.com