



Swathers

LINER





The world of CLAAS	04
Product overview	06
Technology for professionals	10
Rotor dome assembly	12
Tine arms	14
User-friendly features	16
Road transport	18
Top forage quality	20
Four-rotor swathers	26
LINER 4000 / 3600	28
Dual-rotor swathers (central swath laying)	32
LINER 3100	34
LINER 2900 / 2800	36
LINER 2700 / 2600	38
Dual-rotor swathers (side swath laying)	40
LINER 1900 / 1800 TWIN / 1700 TWIN	44
LINER 1700 / 1600 TWIN / 1600	48
LINER 800 TWIN / 700 TWIN	52
Single-rotor swathers	54
LINER 500 PROFIL	56
LINER 450 / 420	58
LINER 370 / 320	60
LINER 500 T / 450 T	62
CLAAS Service & Parts	64
Specifications	66

The world of CLAAS.

We are passionate about what we do, for many reasons – because of the challenges it brings, because it demands all our expertise, and because it is constantly changing. Every day brings something new – and so does every field to be harvested. Similarly, every customer is different, with different requirements. Our job is to meet those requirements, from the lush fields on East Frisian dikes to the drier soils of the Trentino region in Italy, or anywhere in the world.

Thankfully the LINER is equipped for every task. It meets every need, in terms of working width, transport height, ground-contour following, time – and above all, feed quality.

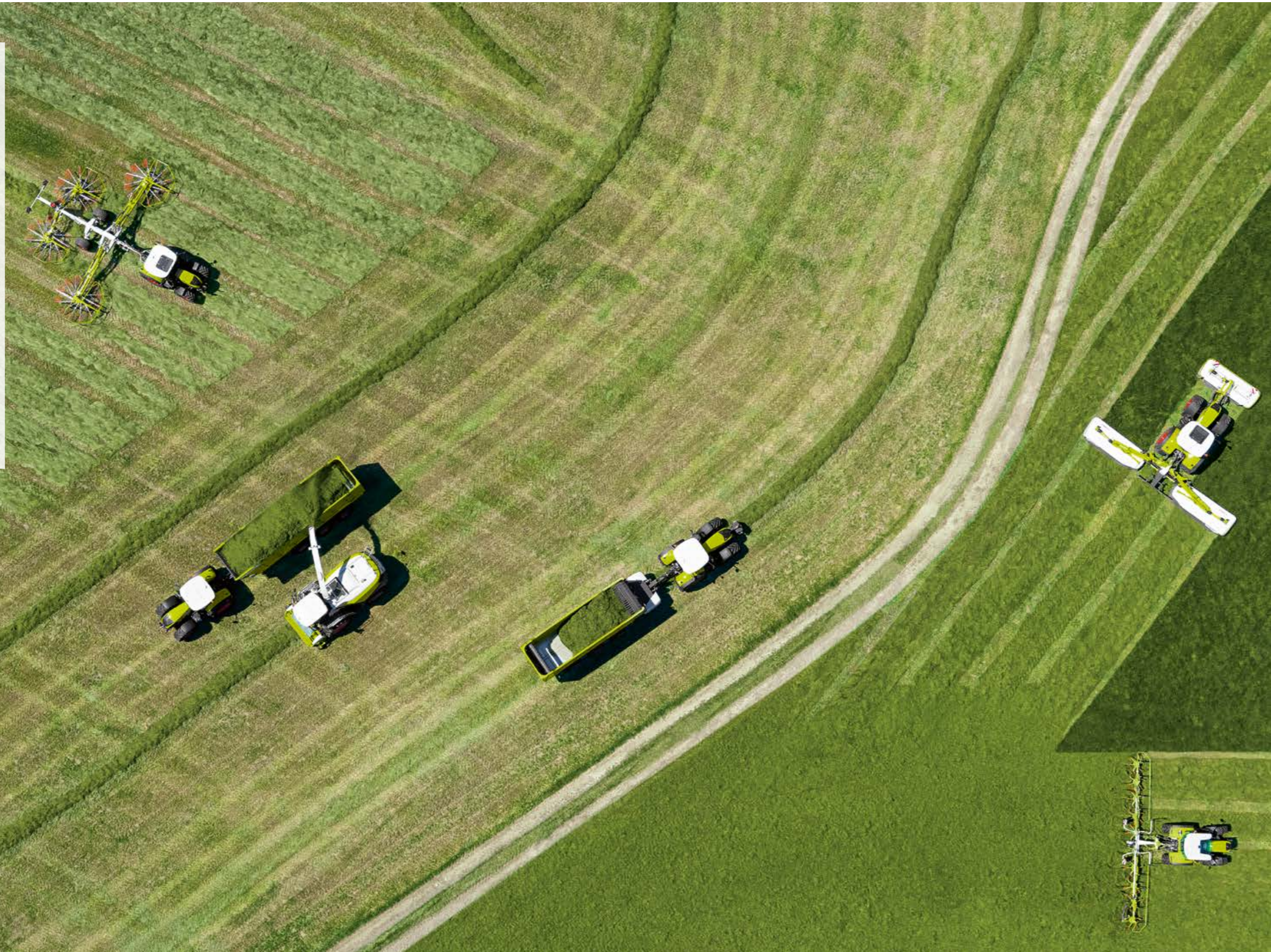

The ultimate in professional equipment – the four-rotor swather.

Versatile and multi-talented – the dual-rotor swather with central swath laying.

The classic – dual-rotor swather with side swath laying.

Compact single-rotor swather.

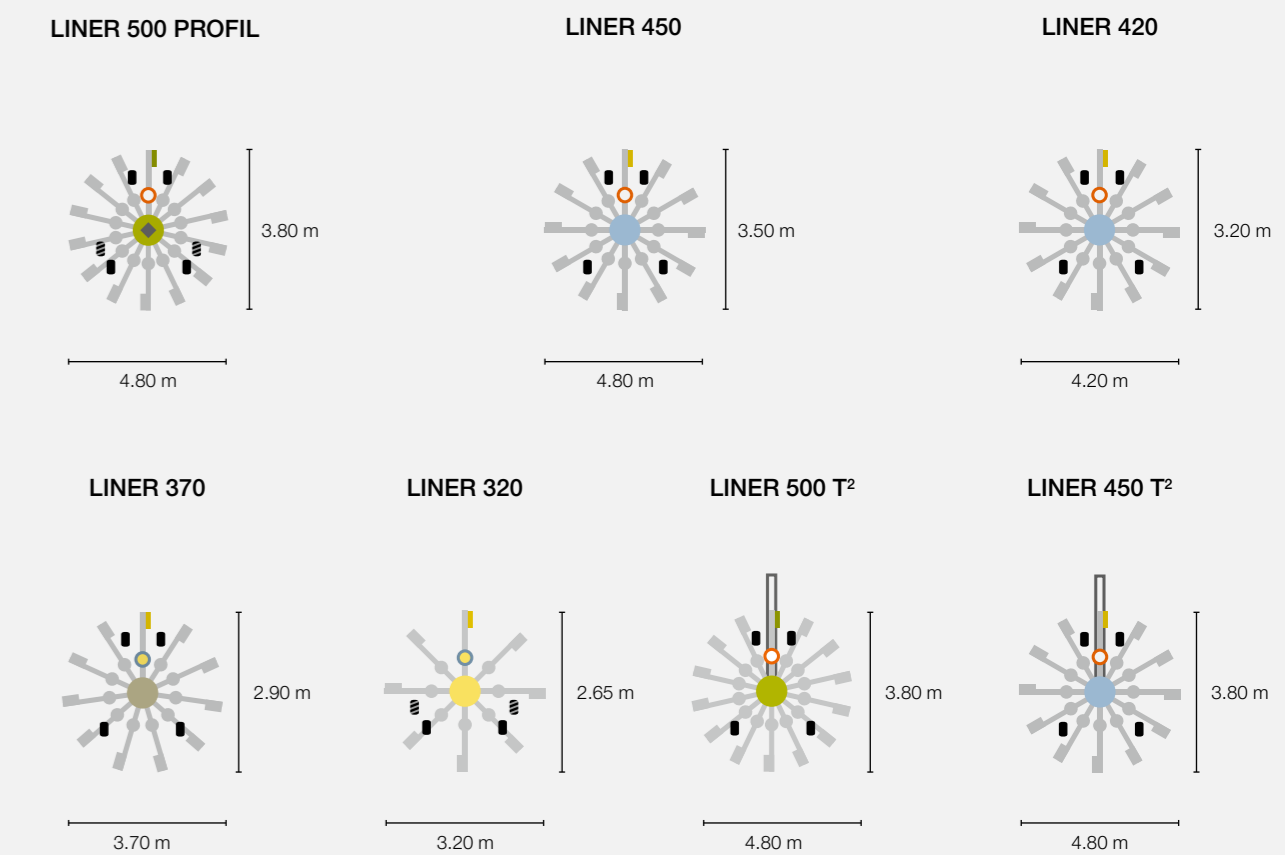
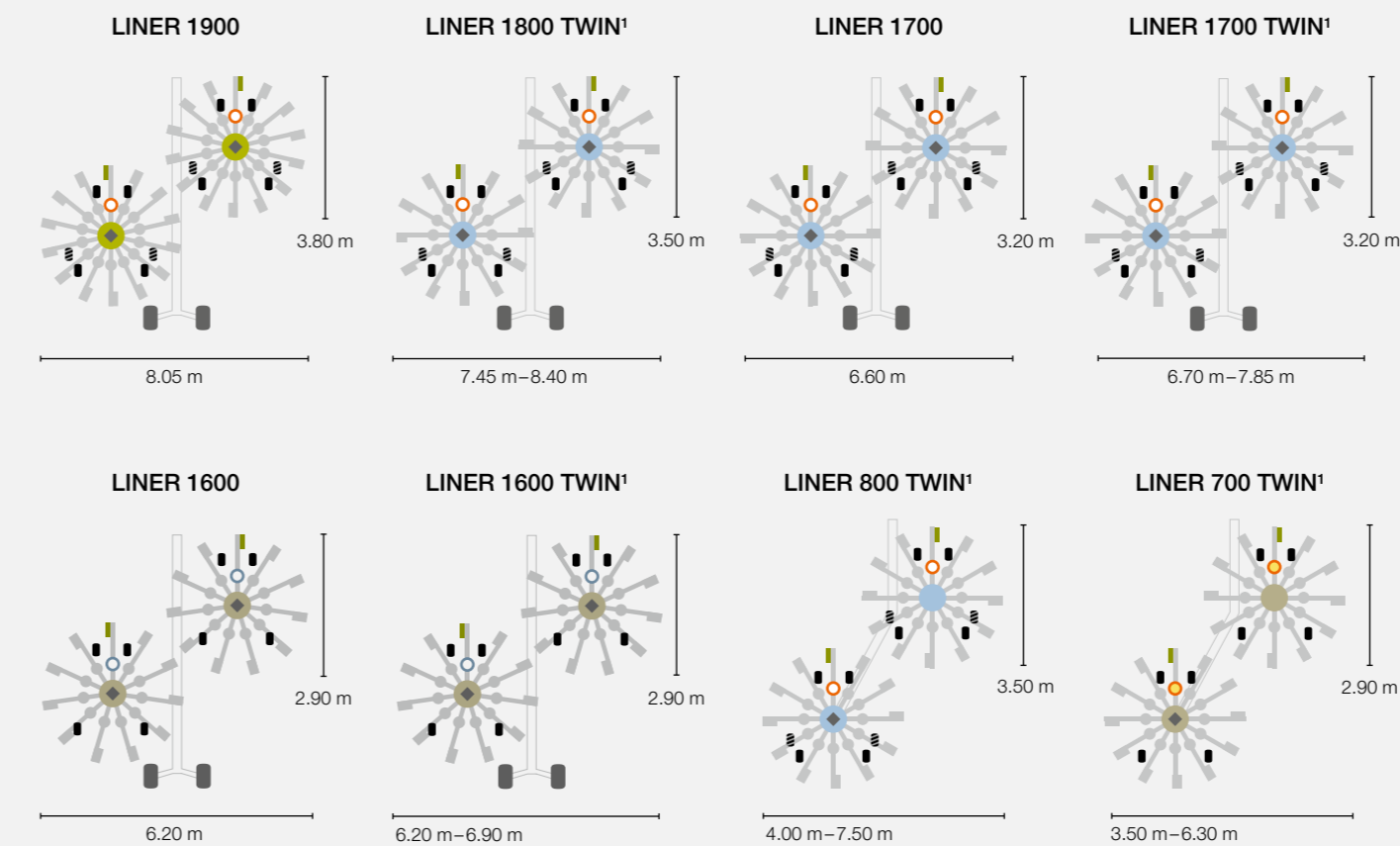
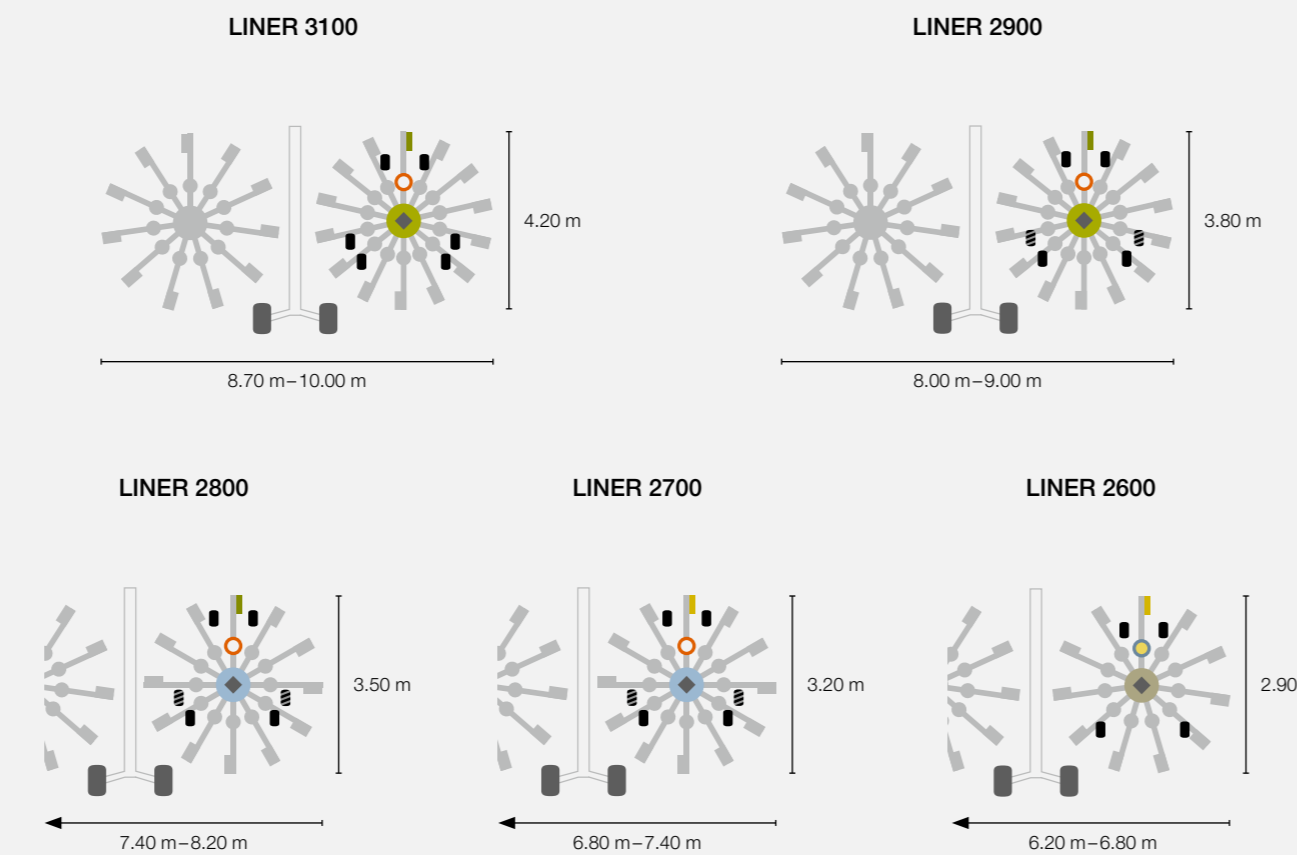
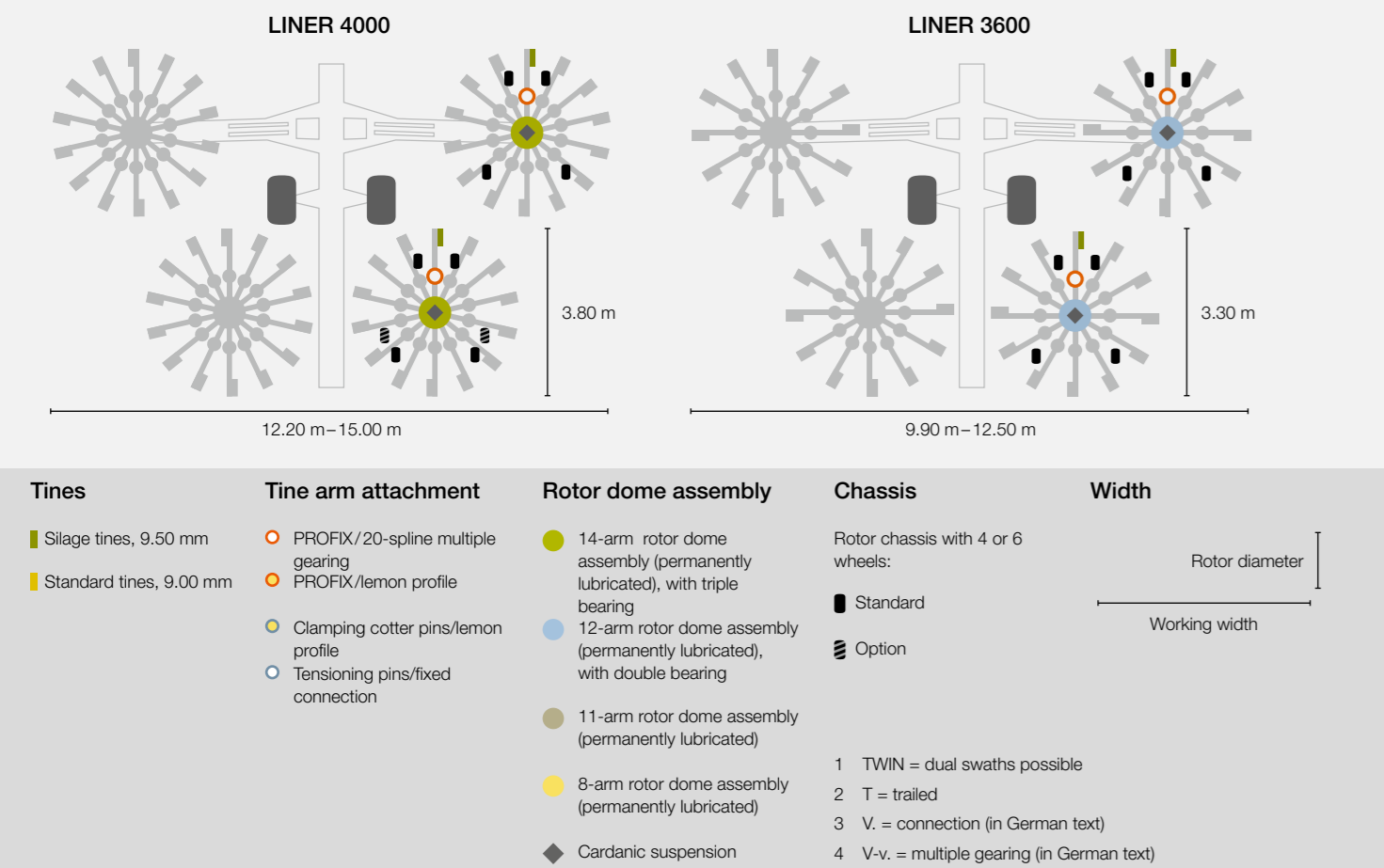

For the best results: swather know-how from CLAAS.

Sophisticated technology.

It goes without saying that our customers want to have the best machines to work with. CLAAS engineers devote all their efforts, every day, to meet that requirement. Our swathers are the most innovative on the market, working choppers until they drop.

The crop harvest centre of competence.

The crop harvesting product development centre at the CLAAS plant in Bad Saulgau is one of the most modern and advanced facilities of its type in the world today. This location is right in the heart of Europe's largest territorial area of green crop fields, making the employees even more aware of the job at hand.

The best for the future, built on the best of the past.

Our customers are looking for versatile solutions that match their specific needs. Farms keep growing and changing, just as we are continuously developing our products. We retain the best of our existing technology, and keep improving everything else.

Team player in the harvest chain.

Conditions keep changing – so do people and harvesting processes. Continuous change places complex demands on machinery and equipment, which we meet with a powerful team of forage harvesting machines. One of our 20 LINER models will make an ideal member of your team.



CLAAS Saulgau GmbH is the company's feed harvesting centre of competence, with one of the most modern product development facilities anywhere in the world today.

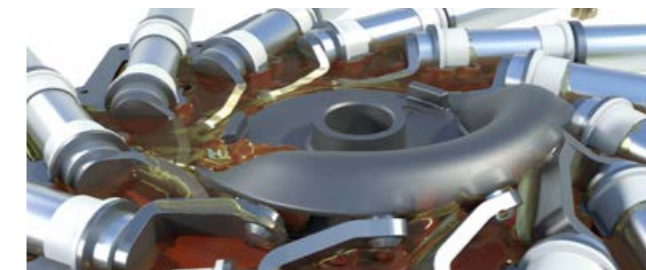

Cam track in oil bath: life-long maintenance-free reliability.



To keep the JAGUAR supplied with enough crop, in 1998 CLAAS introduced the world's first four-rotor swather, and now has two models with top productivity performance in the professional equipment segment.



Cardanic rotor suspension, ensuring rotors adjust to the ground contours independently from all tractor functions.



On-grip tines: the original robust and reliable performer, in all operating conditions.



The patented PROFIX tine arm bracket with multiple gearing: easy and convenient tine arm fitting and removal.



The unique chassis design of the CLAAS side swather allows lift heights of up to 70 cm.



In the event of a collision, the tine arms snap off at a set bending point, preventing any serious damage.



Tandem axle, for optimum tine position at even higher driving speeds.

For more efficient swathing,
we have raked up a heap of really clever ideas.

Technology for professionals.

When it comes to technology, you expect the best, and we welcome that. Because that challenges us to keep getting better, and to keep coming up with new ideas. Great technology is built on meticulous attention to each and every detail, to keep the entire machine running smoothly. So we have focused all our know-how on paring our LINER technology back to the key priority: the consistent delivery of peak performance.

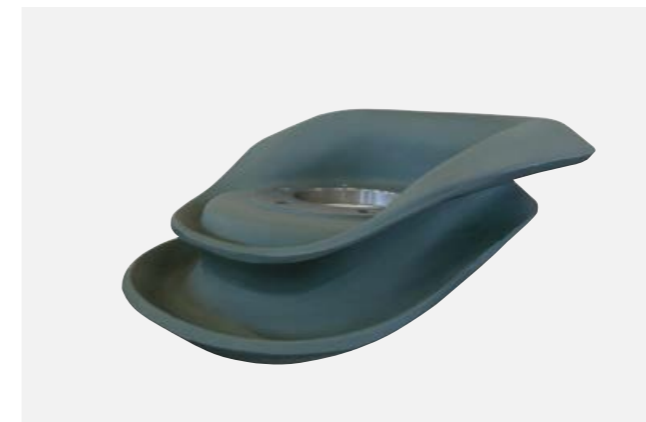
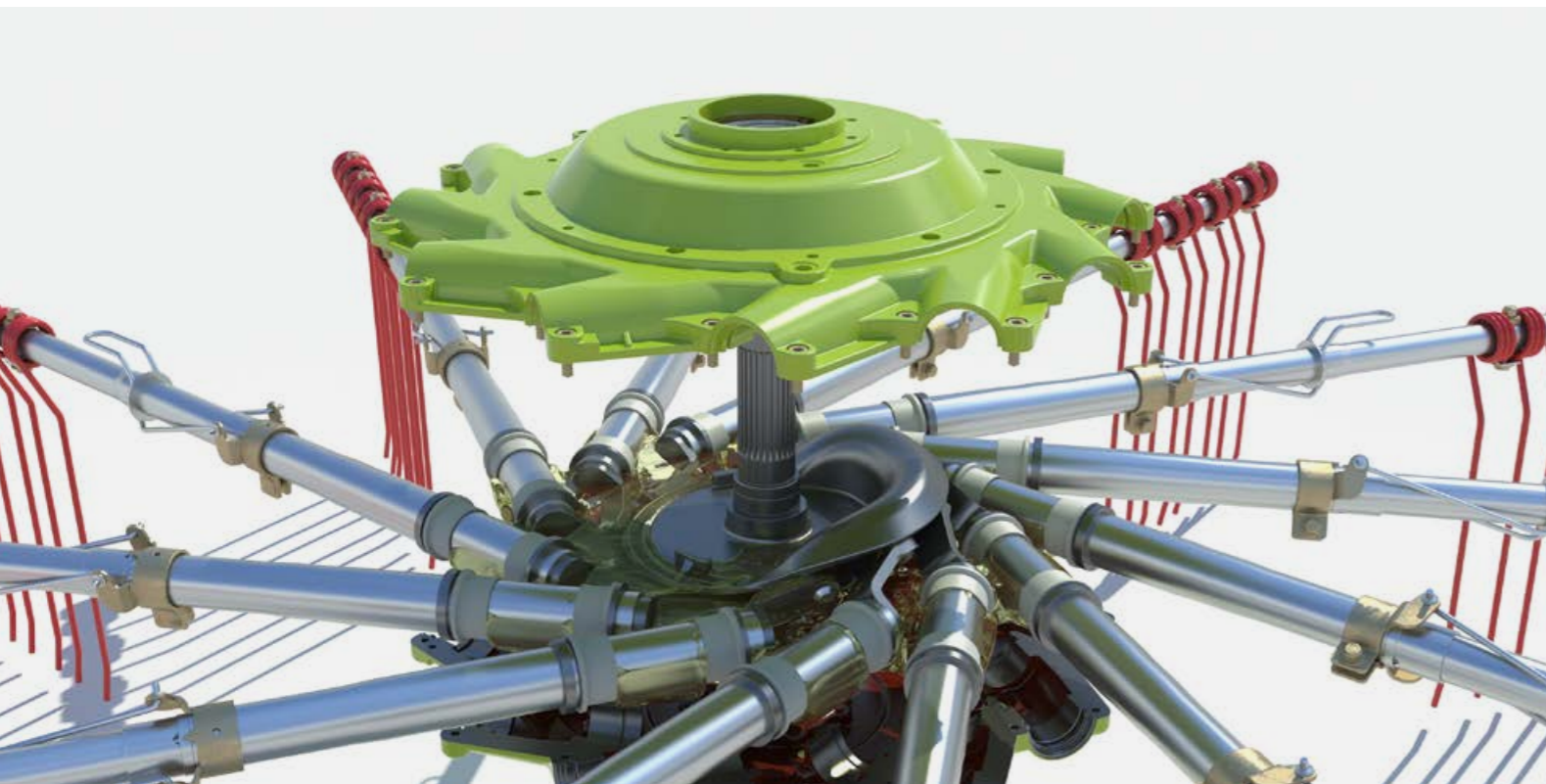

The CLAAS long-running cam track.

High performance under all conditions – its spheroidal graphite iron construction gives the cam track the strength required to withstand any load. The large diameter and the gentle rise of the cam track ensure that the thrust forces from the turning momentum are minimised. As a result, the tine arms operate smoothly, giving a clean raking action without material fatigue, even during periods of prolonged use.

Compact: robust 11- or 8-arm rotor dome assembly.

Some of the small LINER models are fitted with a smaller rotor dome assembly. But here again the steel cam rollers are continuously lubricated in an oil bath, with the robust cast housing hermetically sealed and maintenance-free. The tine arm brackets are secured to the cam track arms either by means of clamping cotter pins, or via a positive connection with a lemon profile.

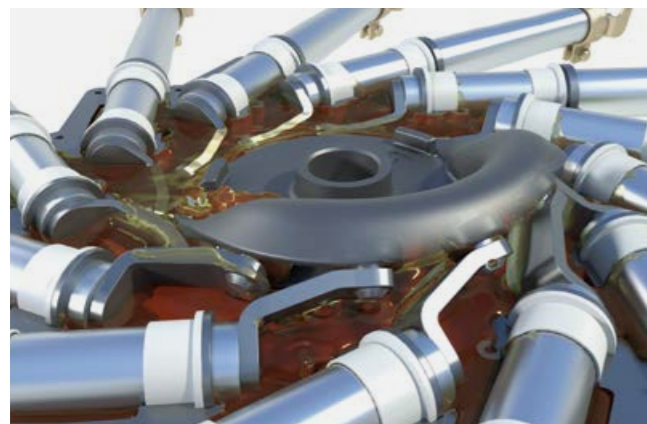

Continuously lubricated rotor dome assembly for professional operators.

The swathing transmission is located in a solid cast housing (rotor dome assembly), which is filled with oil and hermetically sealed. This means the core component of the LINER is protected from soiling, and is therefore maintenance-free. The cam rollers and all moving parts run smoothly in an oil bath, with virtually no friction. This provides optimum lubrication, for maximum service life.

Built to last.

The LINER's operating reliability and stamina make it an ideal part of the core forage harvesting team. To ensure clean swathing results when they matter most, all machine parts are designed to meet the most rigorous requirements.

The cam track arms have a triple-bearing system in the 14-tine arm rotor dome assembly, and a dual-bearing arrangement in the 12-tine arm version. The plain bearings are generously dimensioned and wear-resistant. This reduces wear on the cam rollers, protecting them against both horizontal and vertical loadings.

Drive design concept.

LINER swathers feature a highly reliable, entirely external drive train, ensuring ease of access. The main driving force is transferred to the rotors via an auxiliary gearbox with intelligent gear ratios. That means you are always working at optimum revolutions, which reduces fuel consumption and also protects the crop material. An integrated freewheel mechanism is fitted as standard, to protect the rotors against overload.

Low maintenance.

The LINER is an incredibly low-maintenance machine, with a 250-h lubrication interval for the universal joints of the drive shafts, and a 50-h interval for the travel drive shaft.

- Continuously lubricated, maintenance-free rotor dome assembly in all models
- Intelligent drive concept with individual rotor overload protection
- Robust and durable cam track, made of spheroidal graphite cast iron

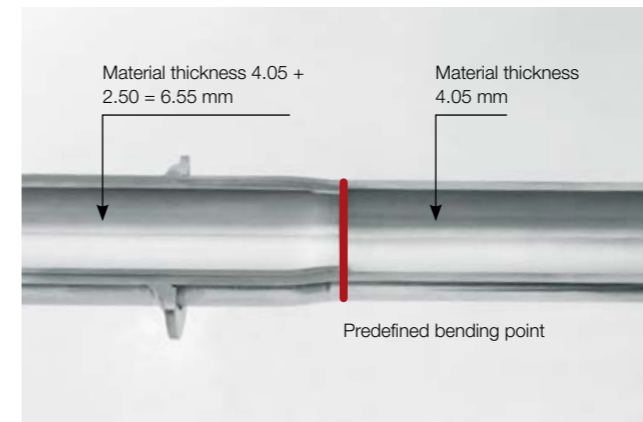
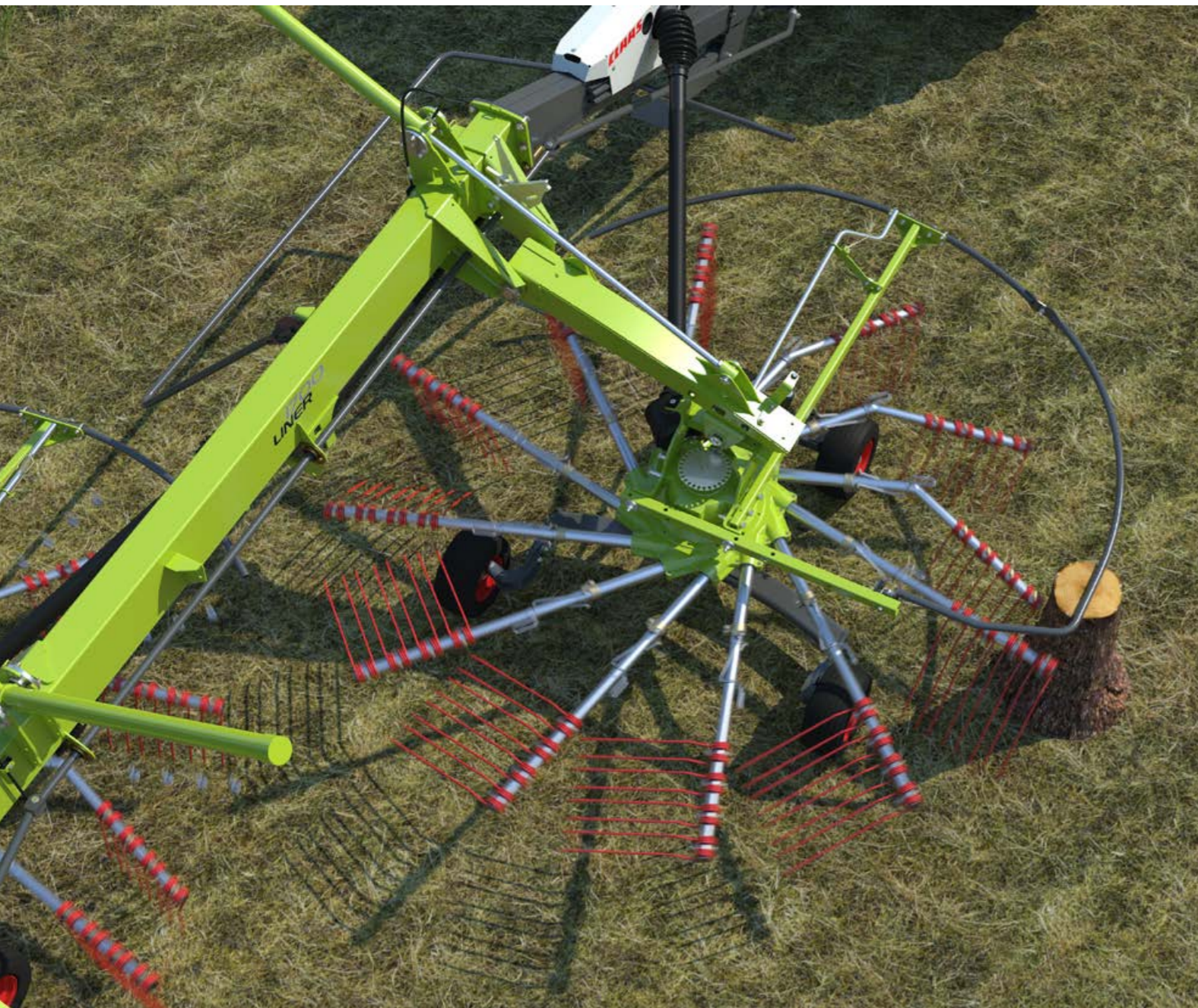

Patented PROFIX system.

In the event of a collision with an extraneous object, the tine arms deflect at a predefined bending point and are then easily replaced, thanks to the patented PROFIX bracket mounting. The bending points are located outside the rotor dome assembly, which therefore remains undamaged. All PROFIX tine arm attachment components can be replaced in a matter of moments, at minimum expense.

The 20-spline multiple gearing attachment keeps the tine arms firmly attached, with no play, and therefore no wear. The seating position is clearly indicated with marker arrows.

Predefined bending points in all models.

In the smaller 11-arm rotor dome assembly, the tine arms are attached with PROFIX, clamping splints or tensioning cotters, according to the model. In the 8-arm rotor dome assembly, clamping splints are used. In both rotor dome assemblies, in the event of a collision the tine arms deflect at a predefined bending point, and can be immediately replaced.

Strong arms for every rotor.

The generous tube diameter and wall material thickness make the tine arms extremely strong. The tine arm length varies according to the model, so the same type of rotor dome assembly can have different rotor diameters (see table).

Rotor diameter			
14-arm rotor dome assembly	12-arm rotor dome assembly	11-arm rotor dome assembly	8-arm rotor dome assembly
4.20 m or 3.80 m	3.50 m, 3.30 m or 3.20 m	2.90 m	2.65 m

- Predefined bending points on all tine arms
- Faster tine arm replacement in the event of a collision, with the PROFIX attachment system
- Top-quality materials for maximum strength

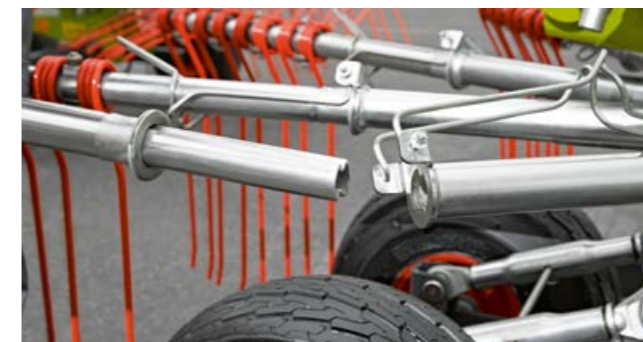

Lemon profile attachment and PROFIX tine arm attachment system in the LINER 700.



Lemon profile attachment and clamping splint in the LINER 370 and 320.

First work, then relax and enjoy yourself, they say – with the LINER you can do both at once.



- Clean swath, thanks to step sequencing and maximum lift heights
- Narrow turning circle safe road transport
- Easy adjustment of working height and rake width

Adjustable hydraulic step sequencing.

On folding up into the transport position, or when lifting at the headland, the rotors are first raised parallel to the ground, and only then turn inwards. This means the swath is not spoiled by rotating tines. In the lifting operation, the front section of the rotor is raised first and, during lowering, the rear chassis wheels contact the ground before the front wheels. As a result, the tines do not dig into the soil, and the harvested crop stays clean.



Maximum lift heights for clean swaths even in headlands.

Unmatched lifting heights.

The maximum lifting height in headlands allows passage over even the largest swaths. So you can turn quickly, with no effect on the clean swath.



Dynamic handling, even in a tight space.

Maximum manoeuvrability.

The maximum steering lock is marked on the drawbar. This is a great advantage in the field, and essential when negotiating narrow entrances, for example.

Flexible rake height and width.

Both working height and rake width are easily adjustable on all models. For optimum rake width adjustment, on the larger models, there is also a scale on the telescopic arms. The rake height can be read off the central shaft of the rotor chassis at any time, and adjusted as required.



Keeping it flexible, with the rake height adjustment scale.

Convenience both on and off the road.



- Road transport height of less than 4.00 m
- Low centre of gravity means excellent road stability, at speeds of up to 50 km/h
- Tidy cab conditions, with stowage surfaces and holders for all cables and the drive shaft



For some models, the tine arms have to be removed for road transport – but they can be stowed away in no time at all.



All tidied away: the right solution for every model.

Safe, compact and fast transport on the road.

Almost all models fold down to a transport height of less than 4.00 m without removal of the tine arms.

On two-rotor and four-rotor swathers, the rotors are folded up, and then hydraulically retracted from the tractor and mechanically or hydraulically secured for transport. This is both convenient for the user and extremely safe: the LINER's low centre of gravity ensures excellent on-road stability, even at travel speeds of up to 50 km/h.

In models with larger rotor diameters, the tine arms are quickly and easily removed, thanks to the PROFIX attachment system, and stowed in the tine arm brackets provided. For even greater safety, most LINER models are equipped with lights and hazard signs as standard. Otherwise, these features are available as options.



Clean and tidy.

The reliable and easy-to-use stand provides a convenient stowage surface for the drive shaft. And depending on the model, there are also user-friendly holders for hydraulic hoses and cables. So the machine can be parked away tidily, out of harm's way.

Rotatably mounted hose holders avoid any strain on the connection with the tractor.

There is plenty of room around the drive, allowing a steering lock of up to 80°.

Optimum quality for the connoisseur – and satisfaction for all.

Top forage quality.

Because of weather conditions, harvesting windows are often very short. CLAAS forage harvesting machines are therefore designed for reliable operation at maximum efficiency, as the only way to get the crop harvested at the right time. This is the key to top-quality feed, and also protects the soil and grass cover, so next season can be just as successful.





- The cardanic rotor suspension adapts effortlessly to uneven terrain
- Adjustable swathing rotor angle
- Sturdy, flexible tines ensure clean pick-up of the crop

Cardanic rotor suspension.

For three-dimensional adaptation to uneven ground contours, the rotors move both lengthwise and laterally across the direction of travel, independently of the position of the main frame.



Rotor adjustment – simplicity itself.

The swathing rotors are set correctly when placed at the minimum angle of inclination towards the swath. To adjust this angle, simply select the appropriate insertion position on the main shaft of the rotor chassis. This is the only way to ensure complete pick-up of the crop material. The end result is a perfect swath, even at high travel speeds.



When the tine is right...

Not all tines are created equal. The material has to be right, and, more particularly, of the optimum thickness. Both strength and flexibility are required, for clean crop pick-up and transport, without any attached dirt.

CLAAS silage tines achieve this objective, with a thickness of 9.50 mm and an angle of 10° at the bottom of the tine. This ensures reliable on-grip operation in all operating conditions, thanks to continuous enhancement of the product design. CLAAS engineers thrive on this kind of challenge. It's not just about good ideas, but turning them into the best possible solutions. It's also about vision, seeing further than the edge of the next rotor!

Which is precisely why CLAAS is at the leading edge of tine research, along with its specialist know-how in crop flow and ground-contour following.

Firmly grounded, even at high speeds.

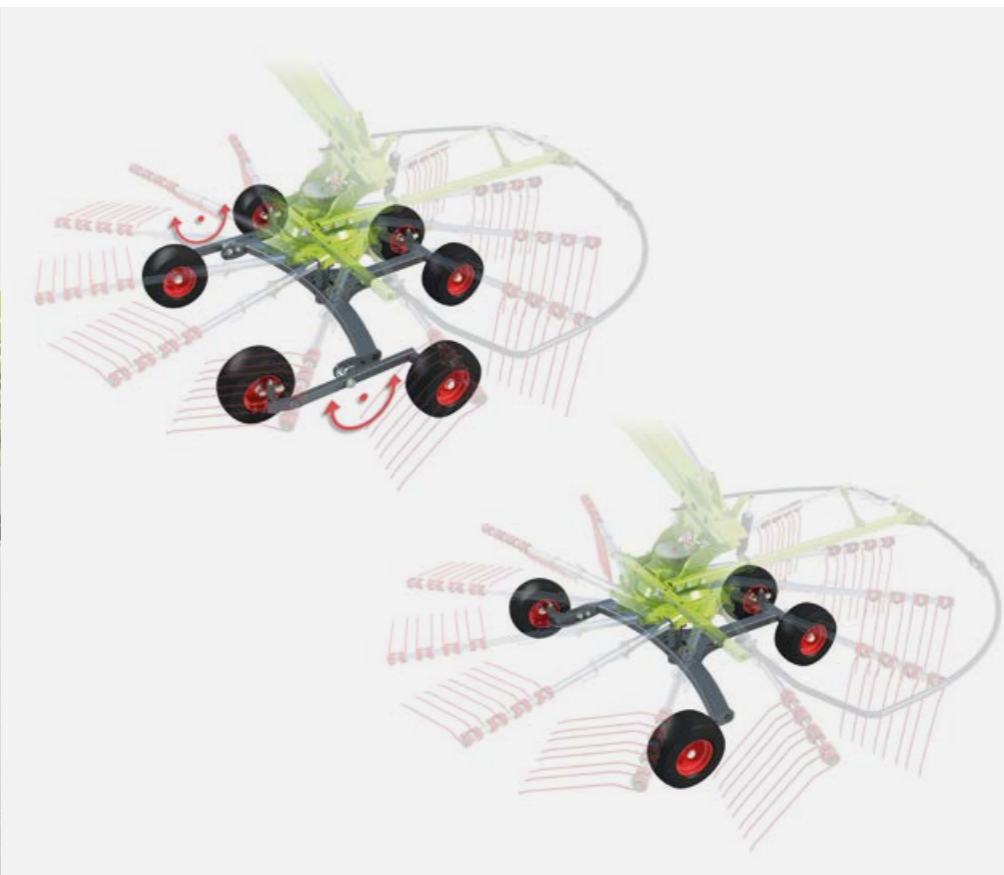

Ideal weight distribution.

The high-volume tyres on the main chassis give the LINER a wide track and a maximum contact area. This means that the weight is distributed optimally, and the soil is protected. The chassis provides the greatest possible stability on slopes, and on roads it enables high speeds of up to 50 km/h.

- Optimum ground-contour following protects both the soil and the crop
- Chassis stability on all types of terrain
- Optional gauge wheel, with tool-free adjustment (depending on the model)

The gauge wheel traces the ground contours.

The four-wheel or six-wheel chassis ensures optimum travel of the swather over the ground. The trailing-steered wheels on the front rotor and at the front of the rear rotor provide optimum soil protection. And the rigid wheels on the rear of the back rotor stabilise the LINER on hilly terrain.

For clean harvesting results over the entire working width, on both sloping and flat ground, the wheels are positioned close to the tine circle of rotation.



Precisely adjusted rake height with additional gauge wheel.

For some single-rotor swathers, a gauge wheel, with tool-free adjustment, is available as optional equipment. This assists in maintaining the correct height, particularly in hilly terrain, and keeps the rotor moving smoothly and cleanly over the ground.

Four times optimum productivity –
as you'd expect from the ultimate professional.

Four-rotor swather.

With the four-rotor swathers, swathing bottlenecks become a thing of the past. The LINER four-rotor swathers stand out from the rest, thanks to their power, intelligence and reliability.

LINER 4000	12.20–15.00 m
LINER 3600	9.90–12.50 m



Unbeatable teamwork –
18 metres in a single pass.



Peak production from combined forces,
based on high working widths.

The recipe for a faster return on higher upfront investment costs is to have the right combination of machines working for you. Bigger working widths significantly reduce overlap between passes – which automatically boosts the productivity of your forage harvester or loading wagon.

18-to-12 mowing strategy with the
DISCO 9200 C.

With the DISCO 9200 C AUTOSWATHER, you can lay a working width of 18.00 m on 12.00 m, using the machine's belt units. The crop is then formed into a single swath with the LINER 3600. The result is 50% more grass in the swath for the JAGUAR harvester following along behind.

Flexibility in the headland.

The benefits are self-evident:

- Adjustable time sequence for lifting and lowering of the front and rear rotor pairs
- Hydraulically adjustable, infinitely variable lift height at headlands to suit every type of forage crop
- Automatically folding swath guard for maximum ground clearance

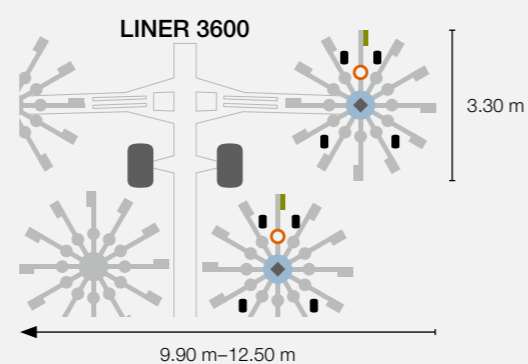
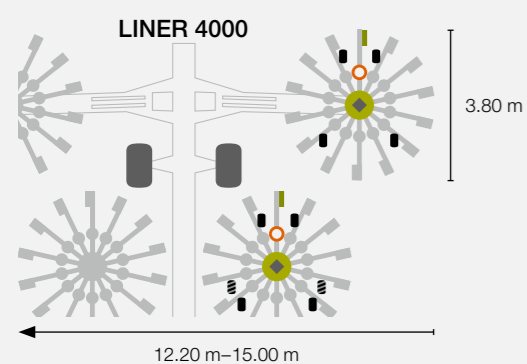

- Silage tines, 9.50 mm
 - PROFIX/20-spline multiple gearing
 - Rotor chassis with 4 or 6 wheels:
 - Standard
 - ▨ Option
 - 14-arm rotor dome assembly (permanently lubricated), with triple bearing
 - 12-arm rotor dome assembly (permanently lubricated), with double bearing
 - ◆ Cardanic suspension
- Rotor diameter
 Working width



Outstanding results – see for yourself.



It couldn't be gentler.

Outstanding soil protection can be achieved with the four-wheel rotor chassis with steered front wheels and a laterally oscillating front axle, or the six-wheel rotor chassis for the rear pair of rotors with additional tandem axles and trailing-steered wheels, available as an option with the LINER 4000.

- Optimal ground-contour following for a clean crop harvest, even at high working speeds
- Powerful spring packs cushion the rotors
- Suspended mounting of the rotor chassis front axle for precise rotor guidance
- Large 380/55-17, 500/50-20 or 620/40 R 22.5 road tyres for optimum ground protection and maximum stability during transportation

Available with different braking systems according to local regulations – hydraulic, air or without brakes.



Both four-rotor swathers are also available as comfort models, with electrohydraulic raking height adjustment.



Comfortable to operate.

The LINER 4000 and 3600 feature comfort hydraulics as standard. Both models are operated via the OPERATOR, the COMMUNICATOR II, EASY on board, the S10 terminal or any other ISOBUS-capable terminal. Manual and electrohydraulic raking height adjustment are available. ISOBUS operation allows various functions to be assigned to the tractor's spool valves, providing additional support for the driver in the form of numerous automated processes.

- Convenient folding in and out from the comfort of the cab
- Hydraulic system for infinitely adjustable swath width
- A range of parameters can be set and stored to match a particular set of operating conditions (such as different swath widths and rake heights)
- Overview of all the services provided and customer data in conjunction with the hectare counter
- Performance optimisation with steering systems
- Lower fuel consumption
- More hectares per hour, from full use of working width capacity

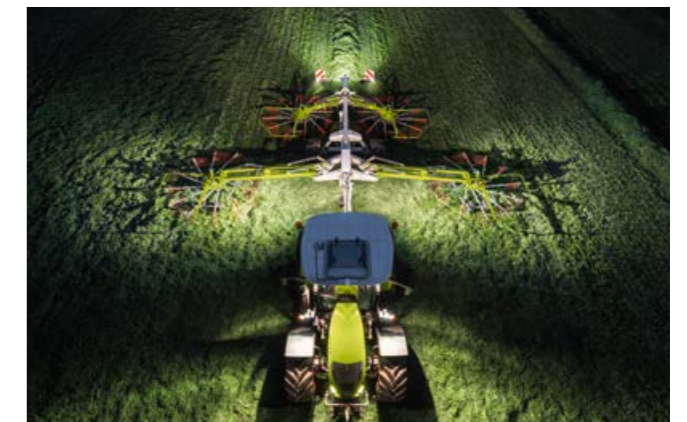

LEDs – so you're never left in the dark.

Even when you need to work well into the night, you can still keep your eye on the job, with five optional LED work lights (one for each rotor and one for the swath). The special light provides maximum contrast, yet without dazzle, ensuring optimal illumination around the swather. The work lights are activated automatically along with the tractor lights when darkness falls.

Swath width adjustable according to the conditions.

In the LINER 3600, the swath width is adjusted mechanically with a grip, while the LINER 4000 has user-friendly hydraulic adjustment from the terminal, accommodating the crop mass characteristics and all widely used pick-ups, from 1.20 to 2.60 m.

Less than 4.00 m without removing tine arms.

The hydraulically lowered transport chassis reduces the transport height of both models to less than 4.00 m, without removing the tine arms (with 22.5" tyres for the LINER 3600).

Best in class –
the power of two.



Dual-rotor swathers with central swath laying.

The reliable alternative to the four-rotor swather should be used when flexibility is called for in addition to a high work rate. Whether working with silage, hay or straw, the LINER dual-rotor swather with central swath laying, and working widths of between 6.20 and 10.00 m, is unmatched in its class.

LINER 3100	8.70–10.00 m
LINER 2900	8.00–9.00 m
LINER 2800	7.40–8.20 m
LINER 2700	6.80–7.40 m
LINER 2600	6.20–6.80 m

Your trusted specialist –
and not just in straw.



LINER 3100

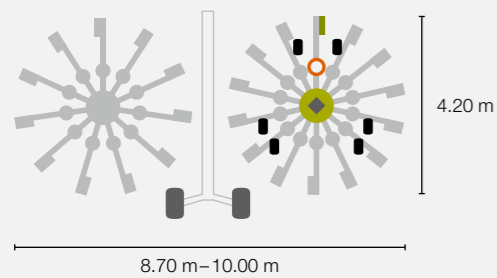

- Silage tines, 9.50 mm
 - PROFIX/20-spline multiple gearing
 - Rotor chassis (6-wheel)
 - 14-arm rotor dome assembly (permanently lubricated), with triple bearing
 - ◆ Cardanic suspension
- Rotor diameter []
Working width []

Power and efficiency with two rotors.

The LINER 3100 is a reliable performer in straw, and in just about any other crop. The working width is infinitely variable with a hydraulic adjustment system, with a scale showing the current setting. When working with a straw crop, the LINER 3100 easily has the working width required to combine two swaths from a 7.50-m combine harvester cutterbar.

Large rotor to cope with even the thickest swaths.

Its generous rotor diameter and the 14 PROFIX tine arms, with five double tines each, ensure that nothing will be left behind. And with a lift height of up to 90 cm, the LINER 3100 passes effortlessly over even the largest straw swaths. The lift height

can be adapted to any harvesting conditions hydraulically via infinitely variable headland stops. At headlands, the swath guard automatically folds upwards, giving maximum clearance.

User-friendly options through flexible control.

Electrohydraulic single-rotor lifting function and hydraulic raking height adjustment can both be conveniently operated via the CLAAS STANDARD TERMINAL with no need for ropes. Alternatively, the single-rotor lift can be operated with no terminal, via a three-way valve.



Time savings and enhanced safety on the road.

To get the transport height down to below 4.00 m, three tine arms are removed from each rotor, and securely attached to the holder provided for the purpose, directly on the rotor.



Ideal for tight curves: the steering system.

As the tractor is steered, the action is passed to the large wheels fitted to the main chassis via the hitching, transfer lever and steering linkage.

The time saver –
efficient, tidy, consistently successful.



LINER 2900.

The LINER 2900, with its 14 PROFIX tine arms, is the ultimate performer and the true silage professional. Contractors therefore like to use it ahead of a forage harvester or loading wagon. And for use with straw, the box-shaped swaths are ideal for producing well-formed bales.



LINER 2800.

The LINER 2800 is a slightly smaller machine, more popular with farmers. Its 12 tine arms also deliver tidy and reliable raking results, but with a more compact swath, with a maximum of 2.20 m.

Consistent, uniform swathing with the LINER.

The LINER 2900 and 2800 have a successful record dating back many years. They consistently provide a perfectly formed swath that is cleanly picked up with the follow-up machines. The swath width is hydraulically adjusted according to the operating conditions, via a double-acting spool valve.

To adjust to a wide range of forage crops, both models have infinitely variable adjustment of the headland stop. The swath guard, with an automatic hydraulic folding system, provides the maximum possible ground clearance.

Optimum ground-contour following.

Both models can be supplied on request with a six-wheel rotor chassis and additional tandem axles, and trailing-steered wheels.

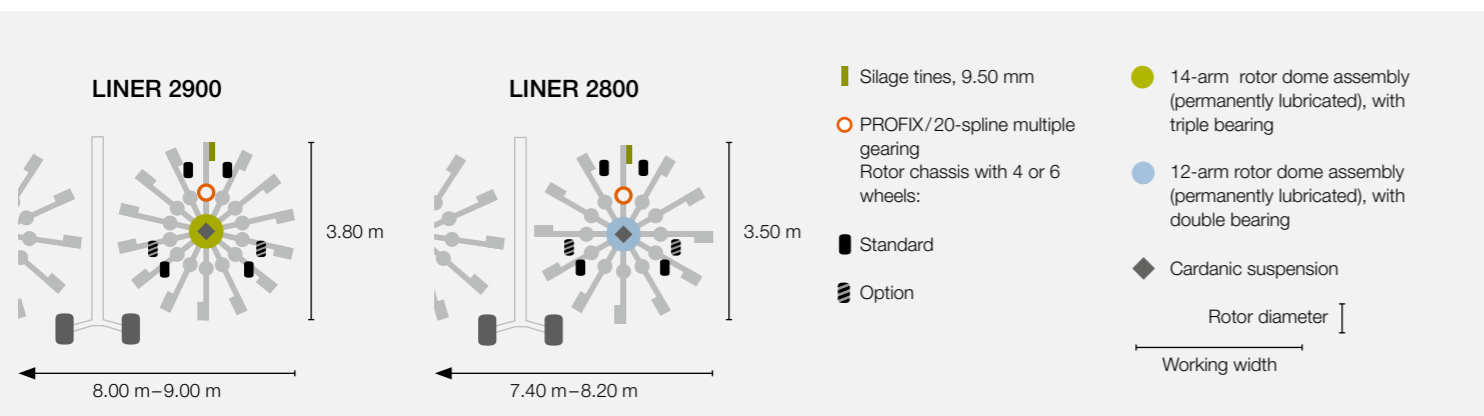

Efficient control system.

The single rotor lifting function and raking height on the LINER 2900 and 2800 can be adjusted using the CLAAS STANDARD TERMINAL without any need for wire ropes. Alternatively, the single rotor lifting function can be controlled via a three-way valve.

Convenient transport.

All models fold down to a transport height of less than 4 m, with hydraulic retraction of the rotors. And the automatic transport lock function makes the operation particularly convenient for the user.

Small farms –
they also face big challenges in the field.



Stability.

The strong frame structure and large tyres result in maximum stability. In all models, the wheels of the frame are controlled with active steering. The benefits include flawless trailing and optimum adaptation to the tractor position.

Powerful and flexible.

The two small central swath models are also highly versatile performers. The swath width is mechanically adjustable according to the operating conditions.

The rotors are secured with a mechanical locking system for road transport.



LINER 2700.

Like its larger counterparts in the central swath segment, the LINER 2700 is fitted with the PROFIX tine arm attachment system. With a maximum swath width of 2.00 m, it is ideal for farms that organise their own baling or loading operations.



LINER 2600.

Unbeatable price-performance ratio. The LINER 2600 has everything a swather needs – including a maintenance-free, hermetically rotor dome assembly, permanently filled with oil.

The LINER 2600, with a maximum swath width of 1.80 m, is particularly impressive in haymaking operations.

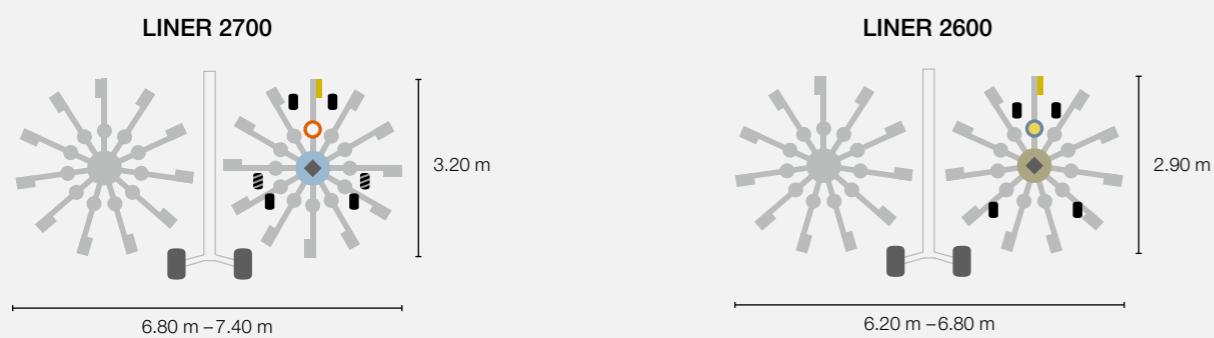

- Standard tines, 9.00 mm
- PROFIX/20-spline multiple gearing
- Clamping cotter pins/lemon profile
- Rotor chassis with 4 or 6 wheels:
- Standard
- Option
- 12-arm rotor dome assembly (permanently lubricated), with double bearing
- 11-arm rotor dome assembly (permanently lubricated)
- Cardanic suspension
- Rotor diameter
- Working width

The bigger the family –
the wider the range of skills and talents.

New arrivals in the side swathing range.

We've added a further three models to the product range. The dual-rotor swathers with side discharge and three-dimensional rotor frame guarantee meticulous swathing in all situations.

LINER 1900	8.05 m
LINER 1800 TWIN	7.45 m – 8.40 m
LINER 1700	6.60 m
LINER 1700 TWIN	6.70 m – 7.85 m
LINER 1600	6.20 m
LINER 1600 TWIN	6.20 m – 6.90 m

Worm swathers too (i.e. trailed machines, with no extra chassis) offer both flexibility and outstanding productivity, even with low crop mass quantities, with working widths between 3.50 and 7.50 m.

LINER 800 TWIN	4.00 m – 7.50 m
LINER 700 TWIN	3.50 m – 6.30 m

New features



Sometimes the best way to lead is to follow – when it comes to ground contours, for example.

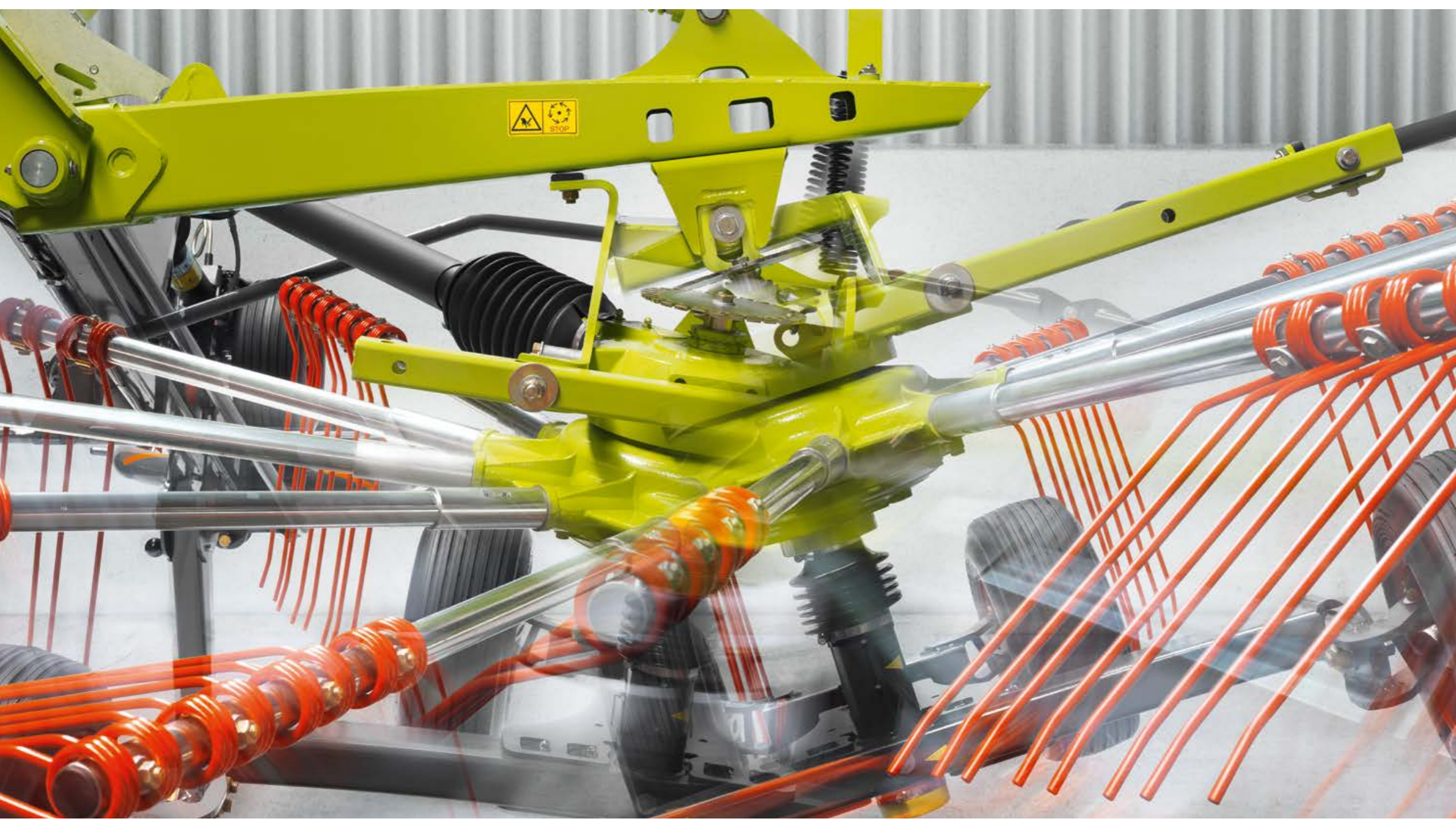

For superior swathing: trailed cardanic suspension.

The innovative rotor suspension on a stable ball coupling mount allows both lateral and longitudinal rotor oscillation, independently of the main frame. The combination of maximum oscillation travel and outstanding stability provides optimum rotor adaptation to even deep ruts and bumps. As a result, the new LINER generation delivers superior swathing outcomes, all the time, in any conditions.

"Inferior feed equals poor quality livestock."

High-quality forage is the key to success. That means choosing the best time for harvesting, and then handling the crop correctly. This starts with the ground-contour following, because our farmers can achieve their targets only if the harvesting machines produce a clean crop:

- Low foreign material content in stock feed, for sustainably healthy, productive animals.
- Consistently high-value mix of grass and herb species, thanks to protection of the sward.



Annette Jilg works in the Crop Farming and Feed Storage section of the Baden-Württemberg Agricultural Centre for Cattle, Crop, Dairy and Deer Farming and Fisheries (LAZBW) in Aulendorf, and knows just how important a low foreign material content is for high feed quality.



New arrivals –
at the top end of the family.



LINER 1900.

The LINER 1900, with working width of 8.05 m and rotor diameter of 3.80 m, is the largest, highest-performance side swather. It is ideal for all professional silage businesses and farm contractors. By combining two swaths, material from a working width of up to 16 m can easily be formed into a single forage swath. To avoid forage losses, the rotor overlap is infinitely adjustable from the driver's seat in the tractor. The four-wheel rotor chassis with steered front wheels and a laterally oscillating front axle ensures exceptionally smooth running and exact gauging of the ground contour, on any kind of terrain. On request, the LINER 1900 can be supplied with a six-wheel rotor chassis with additional tandem axles and trailing wheels, for even better ground-contour following, high work speeds and top forage quality.

A brief digression: full LINER dual-rotor range, and standardised model naming conventions.

As is already the case for dual-rotor swathers with central swath laying, dual-rotor side discharge swathers now also come with different rotor diameters. The second digit of the model number is always the same for a particular rotor diameter, and the first digit also provides essential information: 2000 models are central swath layers, while 1000 models have side discharge.

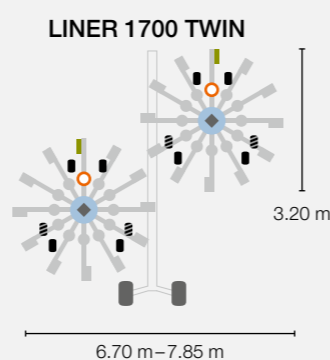
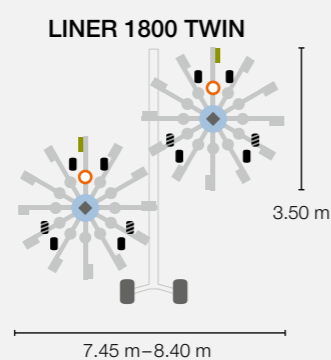
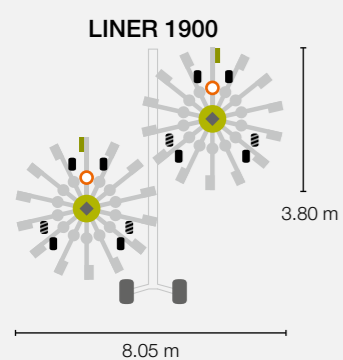

- Silage tines, 9.50 mm
 - PROFIX/20-spline multiple gearing
 - Rotor chassis with 4 or 6 wheels:
 - Standard
 - Option
 - 14-arm rotor dome assembly (permanently lubricated), with triple bearing
 - 12-arm rotor dome assembly (permanently lubricated), with double bearing
 - ◆ Cardanic suspension
- Rotor diameter |
Working width

LINER with side swath laying	LINER with central swath laying	Rotor diameter
1900	2900	3.80 m
1800	2800	3.50 m
1700	2700	3.20 m
1600	2600	2.90 m

Reliable partners –
professionalism guaranteed.

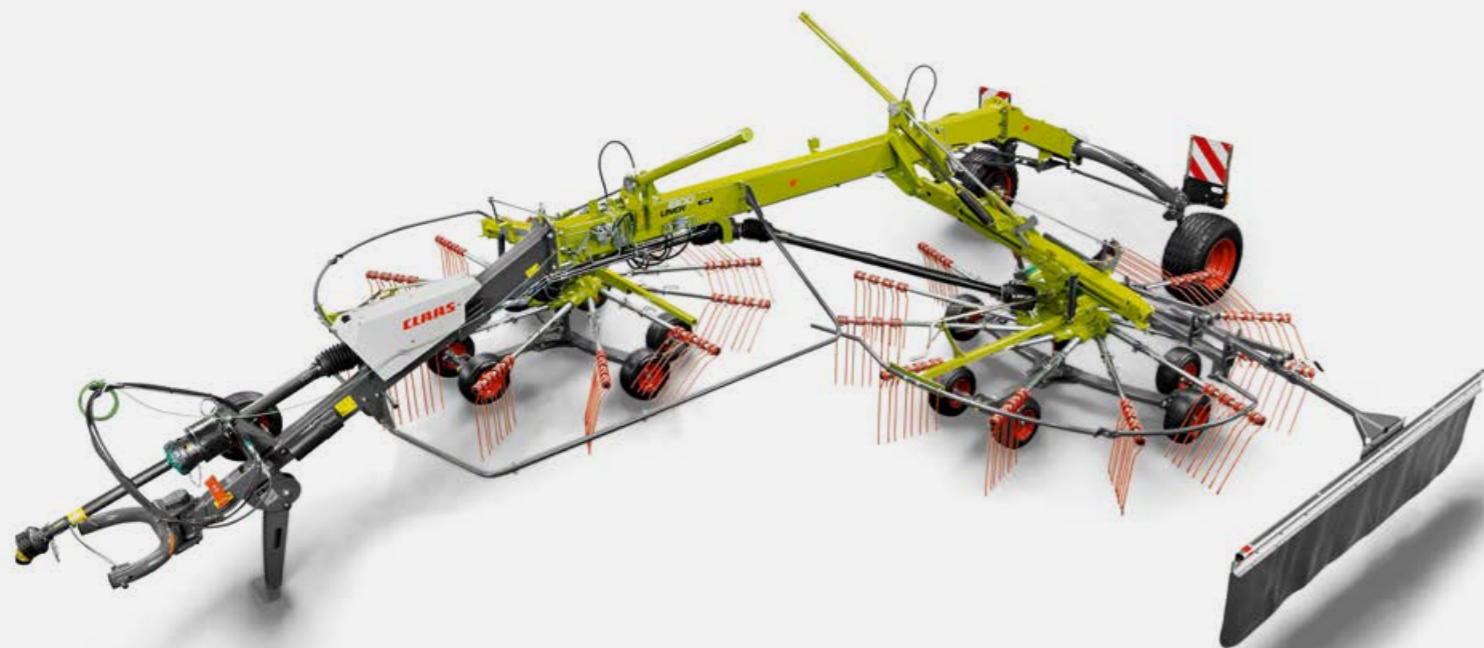

LINER 1800 TWIN and 1700 TWIN. Flexibility guaranteed.

The TWIN function allows flexible adaptability to a range of different conditions. The two individual swaths can be combined to form a large swath for a forage harvester or baler. You also have the option of forming two smaller swaths for overnight swathing, small self-loading forage wagons, round balers or large forage volumes.

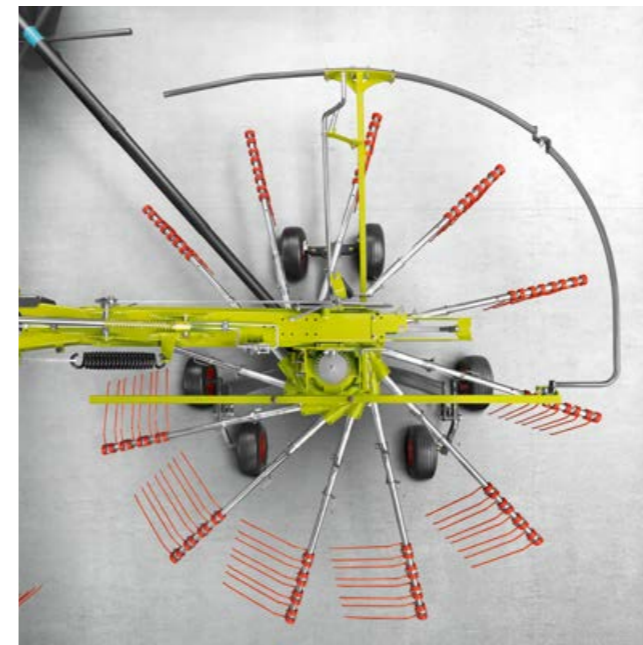

Hydraulic headland stops.

The LINER 1900 and 1800 TWIN models are equipped with an infinitely adjustable hydraulic headland stop. In the LINER 1700 TWIN, this function is performed mechanically, with two positions. The headland stop allows adaption to an incredibly wide range of crop conditions.



Changeover from single to double swath discharge.

The telescopic booms of the LINER 1800 TWIN and 1700 TWIN provide a choice between single and double swath discharge, simply by relocating the stop bolts.

True champions in the hay and straw sector – flexibility is our strength.



Proven LINER reliability.

As well as being consistently reliable, a true hay and straw production champion has to cope confidently with any kind of terrain. The large-size tyres (up to 340/55 R 16) protect soil and sward – whether you opt for a four-wheel chassis, or the six-wheel chassis optionally available for the larger models.

Maximum manoeuvrability through flexible inverted U-frame hitch.

The flexible inverted U-frame hitch with lateral oscillation allows a steering lock angle of up to 80°. An easy-to-read scale is provided for adjusting the rake height on both of the rotor chassis.

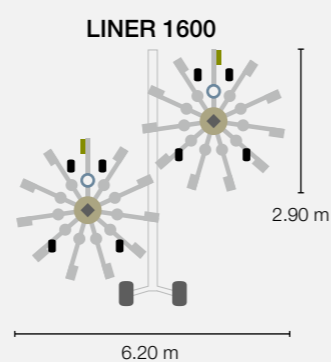
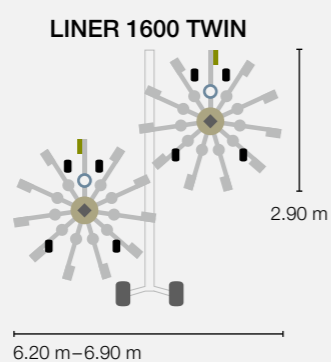
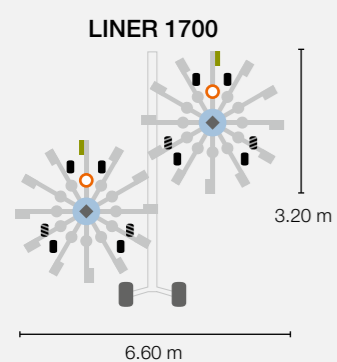

- Silage tines, 9.50 mm
- PROFIX/20-spline multiple gearing
- Tensioning pins/fixed connection
- Rotor chassis with 4 or 6 wheels:
- Standard
- Option
- 12-arm rotor dome assembly (permanently lubricated), with double bearing
- 11-arm rotor dome assembly (permanently lubricated)
- ◆ Cardanic suspension
- Rotor diameter —
- Working width —

Reliable, safe, low-maintenance –
in each and every detail.



Impeccably shaped swaths, even when the machine has been through.

Optimum swath formation even in the headland, thanks to unparalleled lift heights of 50 cm for the LINER 1900 and LINER 1800, 53 cm for the LINER 1700 and 45 cm for the LINER 1600. Even greater lift heights can be set for double-swath discharge.



Rotor manipulation for zero soiling.

Crop soiling effectively prevented with perfectly controlled rotor lift and lowering, also eliminating any risk of damage to the sward.



Controlled lift and lowering.

Adjustable hydraulic sequence valve for time-delayed lifting and lowering of the rotors. The lift and lowering speed can also be adjusted to the tractor's hydraulic system.



Safe and low-maintenance.

External drive train and individually secured rotors, low maintenance, thanks to the 250-h lubrication interval for the universal joints of the drive shafts.



TWIN function.

With the TWIN models, an additional swath guard can be used to rake a double swath (overnight swathing). At haymaking time, for example, this protects already dry material from exposure to moisture at night, before it can be collected.

Unlimited possibilities,
taking the toil out of working.



Efficient, high-performance swathing.

The LINER 800 TWIN and 700 TWIN are the ideal harvest partners for small- and medium-sized farms that require productivity at a reasonable price. The impressive features of these swathers include their flexible working width, low power requirement, user-friendly operation and exceptional raking quality. The generously dimensioned chassis and low centre of gravity make both these models very stable on slopes, and gentle on the soil in all types of conditions. And their outstanding steering characteristics also make them ideal for use in grassland orchard areas.

Road transport.

The LINER 700 TWIN folds down to a transport width of less than 3 m, without removing the tine arms. In the LINER 800 TWIN the rotor diameter is 3.50 m, so the tine arms can be removed for road transport and safely and conveniently stowed directly on the rotor.

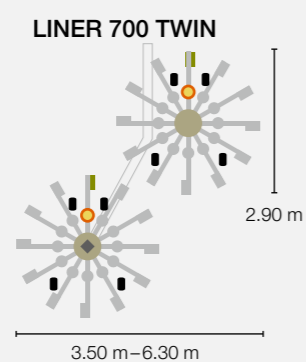
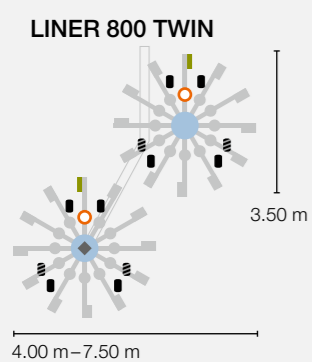

- Silage tines, 9.50 mm
 - PROFIX/20-spline multiple gearing
 - PROFIX/lemon profile
 - Rotor chassis with 4 or 6 wheels:
 - Standard
 - ▨ Option
 - 12-arm rotor dome assembly (permanently lubricated), with double bearing
 - 11-arm rotor dome assembly (permanently lubricated)
 - ◆ Cardanic suspension
- Rotor diameter
 Working width



Generous lifting height for driving over swaths at headlands: up to 50 cm in the LINER 700 TWIN.



Hydraulic sequential control fitted as standard to adjust the time delay between front and rear rotors when raising and lowering.



Parallelogram drawbar is optional on the LINER 700 TWIN and standard on the LINER 800 TWIN.

Just one rotor, but plenty of performance.

Single-rotor swathers.

The LINER single-rotor swathers are specially developed for farmers who prefer to handle their forage harvesting independently, and who often work in smaller fields. The working widths of 3.20 to 4.80 m are ideal for these situations. Whether with three-point hitching or as a towed model, the key features of the LINER single-rotor swathers are precise ground-contour following, high work rates and excellent reliability.

LINER 500 PROFIL	4.80 m
LINER 450	4.50 m
LINER 420	4.20 m
LINER 370	3.70 m
LINER 320	3.20 m
LINER 500 T	4.80 m
LINER 450 T	4.50 m

New features



Stand-alone reliability – single-rotor performance.



On the level.

The CLAAS LINER 500 PROFIL was the world's first single-rotor swather with cardanic rotor suspension. Its three-dimensional adaptation to ruts and bumps, independently of tractor movements, has now been adopted in many other models. As an additional benefit, the cardanic suspension means that the rotor remains horizontal during the lifting operation, allowing greater lift heights.

LINER 500 PROFIL

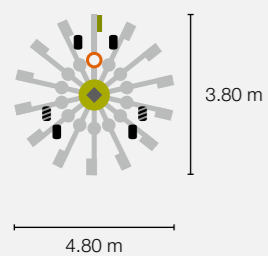

- Silage tines, 9.50 mm
- PROFIX / 20-spline multiple gearing
- Rotor chassis with 4 or 6 wheels:
- Standard
- ▨ Option
- 14-arm rotor dome assembly (permanently lubricated), with triple bearing
- ◆ Cardanic suspension

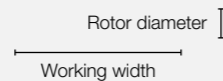

Effortless removal.

The PROFIX bracket mounting ensures the operating safety of the LINER 500, even with the 3.80-m-wide rotor dome assembly.

One swather, offering all the options – a truly versatile performer.

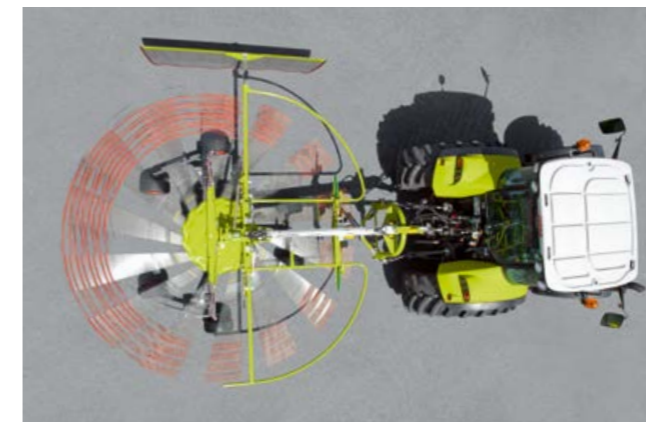

The running gear.

The V-shaped tandem axles are located close to the tine circle of rotation, and provide optimum adaptation to ruts and bumps in the ground. The adjustable lateral inclination is used to adjust for different forage mass levels.

Robust inverted U-frame hitch.

Single-rotor swathers are attached to the two lower links of the tractor with the robust inverted U-frame hitch. The high insertion positions for the upper link provide ample ground clearance in the lifted state, even on smaller tractors. The practical support integrated in the inverted U-frame ensures that the universal shaft is at the right height, within easy reach for attachment, and can be conveniently parked when the swather is unhitched.

LINER 450 and 420.

The LINER 450 and 420 models differ only in their working width. As in all CLAAS single-rotor swathers, maximum lift height ensures well-formed swaths, even in passover areas.

Precision swathing.

The raking height can be adjusted via a crank lever or optionally, hydraulically from the cab, for perfect precision raking. The position of the swath guard can be fixed via an easy-to-operate clamping bolt.

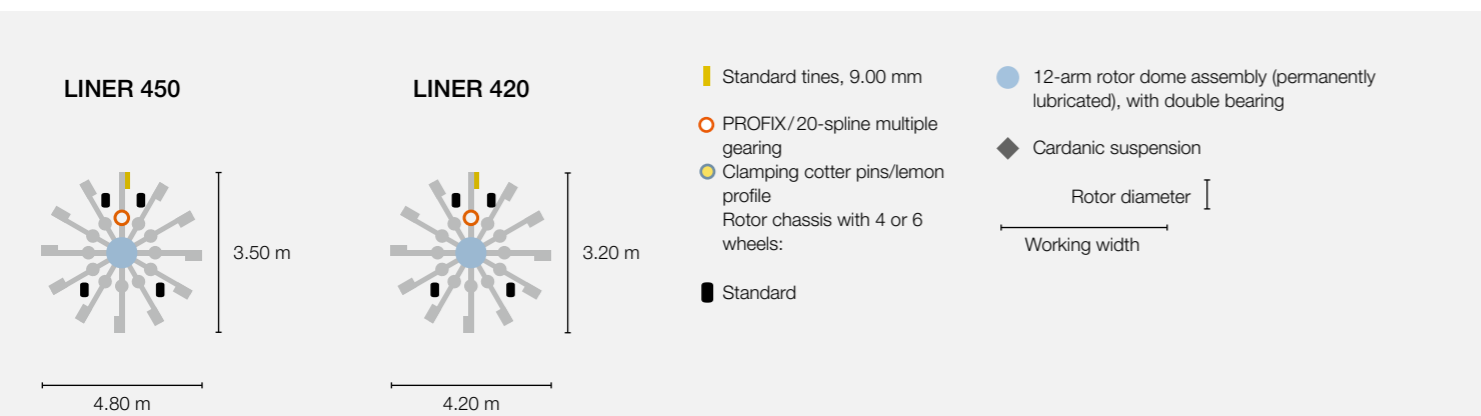

The standard tines on the 450, 420, 370 and 320 models are extremely robust, thanks to a material thickness of 9 mm, and therefore ideal for both hay and silage.

Safe and secure on the road.

Standard spring-supported or optional hydraulically folding protective frames and easy-access transport holders for removable tine arms make it easy to meet the road transport width requirement. An integrated transport lock holds the rotor in place while on the move, and large warning signs are optionally available, with or without lighting.

The CLAAS power drawbar (CKL) relieves the pressure on the attached swather's carrier frame, and the spring-loaded arms counter overrun on downhill slopes. The arms also automatically lock the three-point frame, for safety during road transport.

Small machine, delivering big results.



NEW: Eight-arm rotor dome assembly in the LINER 320.

The LINER 320 has a maintenance-free eight-arm rotor dome assembly. As on other models, the assembly is hermetically sealed and permanently lubricated, and therefore maintenance-free. The LINER 370 has an 11-arm rotor dome assembly.



Tool-free removal of tine arms.

The tine arms, each with three dual tines, have a lemon profile attachment. They are secured in place with clamping splints, for rapid tool-free removal when required.

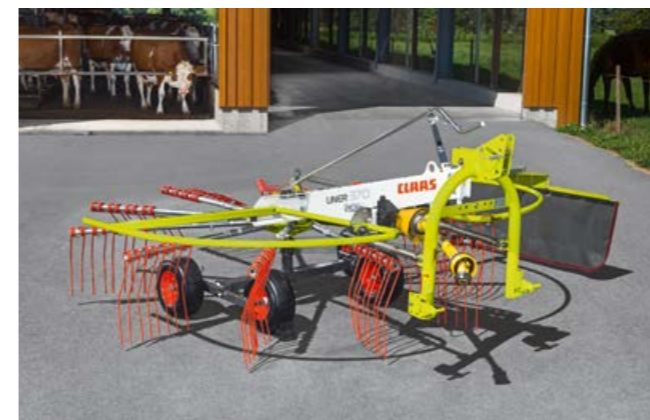

Rotor chassis.

The LINER models 370 and 320 both have a single axle as standard. A tandem axle is also available as optional equipment. The axles are positioned close to the circle of rotation of the tines, for optimum adaptation to uneven ground contours.

LINER 370

LINER 320

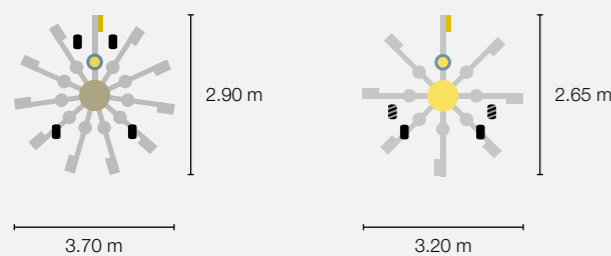

- Standard tines, 9.00 mm
- 11-arm rotor dome assembly (permanently lubricated)
- Clamping cotter pins/lemon profile
- 8-arm rotor dome assembly (permanently lubricated)
- Rotor chassis with 4 or 6 wheels:
- Standard
- ◆ Cardanic suspension
- ▨ Option
- ⌈ Rotor diameter
- ⌋ Working width



Reliability based on practically maintenance-free technology: the LINER 370 and 320.

With their mix of an outstanding price-performance ratio and virtually maintenance-free technology with a long service life, these two LINER models are clearly the machines of choice in their class.

Power to the rear –
the trailed models.



T is for trailed.

To make the benefits of high-performance swathers available to farms using smaller tractors, CLAAS also supplies two trailed variants: the LINER 500 T and 450 T. Both these LINER models stay in position behind the tractor even in hilly terrain, whether hitched to a linkage drawbar or swinging drawbar,



Just hitch up and drive away.

The trailed single-rotor swather is operated with just one single-acting spool valve.

- The hitch design enables raising of the rotors parallel to the ground
- The rotor angle in the direction of travel is set with a built-in crank handle fitted in the drawbar cylinder, or the optional gauge wheel
- Optional: parallelogram drawbar for connection to rigid pulling mechanisms



LINER 500 T

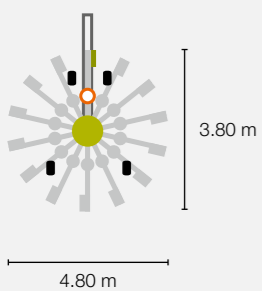

LINER 450 T

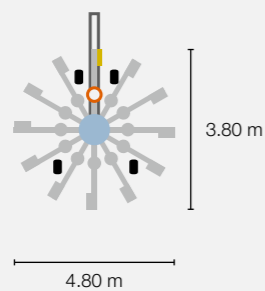

- Silage tines, 9.50 mm
 - Standard tines, 9.00 mm
 - PROFIX / 20-spline multiple gearing
 - Rotor chassis (4-wheel)
 - 14-arm rotor dome assembly (permanently lubricated), with triple bearing
 - 12-arm rotor dome assembly (permanently lubricated), with double bearing
 - ◆ Cardanic suspension
- Rotor diameter []
- Working width []

Whatever it takes – CLAAS Service & Parts.



Your requirements count.

You can always rely on us: we'll be there whenever you need us – everywhere, quickly and reliably, around the clock if necessary, with precisely the solution that your machine or business requires. Whatever it takes.

ORIGINAL parts and accessories.

Specially matched to your machine: precision-manufactured parts, high-quality consumables and useful accessories. We will supply exactly the right solution from our comprehensive product range to ensure that your machine is 100% reliable. Whatever it takes.

For your business: CLAAS FARM PARTS.

CLAAS FARM PARTS offers one of the most comprehensive ranges of parts, regardless of brand and sector, for all agricultural applications on your farm. Whatever it takes.

Always up to date.

CLAAS dealers are among the most efficient agricultural technology companies in the world. Our service teams are ideally qualified and equipped with the all-important special tools and diagnostic systems. CLAAS Service stands for high-quality work which meets all your expectations with regard to expertise and reliability. Whatever it takes.

Reliability can be planned.

With our service products, you can increase your machine reliability, minimise your risk of breakdowns, and budget with confidence. CLAAS MAXI CARE offers planned reliability for your machine. Whatever it takes.

Worldwide coverage from Hamm.

Our central spare parts warehouse delivers all ORIGINAL parts quickly and reliably all over the world. Your local CLAAS partner can supply the right solution for your harvest or your business within a very short time. Whatever it takes.

Problem solving by remote diagnostics: CLAAS TELEMATICS.

CLAAS TELEMATICS on your machine brings two important advantages: fast assistance from CLAAS service technicians and a more profitable operation, thanks to wireless networking. We can be there, on the spot, to solve your problem – even when you can't see us. Whatever it takes.



The CLAAS Parts Logistics Center in Hamm, Germany, stocks more than 155,000 different parts with warehouse floor space of over 100,000 m².



LINER side swathers¹		1900	1800 TWIN²	1700 TWIN²	1700	1600 TWIN²	1600	800 TWIN²	700 TWIN²	500 PROFIL	450	420	370	320	500 T	450 T		
Dual-rotor swathers																		
Mounting								Swinging draw-bar/hitch	Swinging draw-bar/hitch	Single-rotor swathers							Swinging draw-bar/hitch	Swinging draw-bar/hitch
Hitch category		Cat. II	Cat. II	Cat. II	Cat. II	Cat. II	Cat. II	–	–	Cat. II	Cat. I + II	Cat. I + II	Cat. I + II	Cat. I + II	–	–		
Working width	m (DIN)	8.05	7.45–8.40	6.70–7.85	6.60	6.20–6.90	6.20	4.00–7.50	3.50–6.30	4.80	4.50	4.20	3.70	3.20	4.80	4.50		
Transport width																		
With tine arms mounted	m	2.99	2.99	2.89/2.99	2.89/2.99	2.89/2.99	2.89/2.99	3.60	3.00	3.80³	3.50³	3.20³	2.98³	2.80	3.80³	3.50³		
With tine arms removed	m	–	–	–	–	–	–	2.42	2.42	2.40	2.30	2.00	1.53¹/1.75	2.25¹/2.45	2.50	2.20		
Transport height																		
With tine arms mounted	m	3.99	3.99	3.99	3.99	3.64	3.79	–	–	–	–	–	–	1.52	–	–		
With tine arms removed	m	–	–	–	3.67	–	–	–	–	2.45	2.45	2.35	2.15	2.15	2.45	2.45		
Parking length (transport position)	m	9.64	9.19	8.66	8.66	8.25	8.25	8.55	8.00	3.30	4.10	3.80	2.55	2.43	4.40	5.25		
Weight approx.	kg	2590	2480	2220	2080	1950	1810	1620	1440	805	650	560	450	380	785	660		
Rotors	Qty	2	2	2	2	2	2	2	2	1	1	1	1	1	1	1		
Rotor diameter	m	3.80	3.50	3.20	3.20	2.90	2.90	3.50	2.90	3.80	3.50	3.20	2.90	2.65	3.80	3.50		
Tine arms per rotor	Qty	14	12	12	12	11	11	12	11	14	12	12	11	8	14	12		
Dual tines per arm set	Qty	4	4	4	4	4	4	4	4	4	4	4	3 (4 ◊)	3	4	4		
Tine diameter	mm	9.50	9.50	9.50	9.50	9.50	9.50	9.50	9.50	9.50	9.00	9.00	9.00	9.00	9.50	9.00		
PROFIX tine arm bracket		●	●	●	●	–	–	●	●	●	●	●	–	–	●	●		
Swath-laying position		left	left	left	left	left	left	left	left	left	left	left	left	left	left	left		
Two-wheel rotor chassis		–	–	–	–	–	–	–	–	–	–	–	●	●	–	–		
Four-wheel rotor chassis		●	●	●	●	●	●	●	●	●	●	●	●	◊	●	●		
Six-wheel rotor chassis		◊	◊	◊	◊	–	–	–	–	◊	–	–	–	–	–	–		
Tyres																		
Rotor chassis	16x6.50-8 10 PR	2x4 (2x6 ◊)	2x4 (2x6 ◊)	2x4 (2x6 ◊)	2x4 (2x6 ◊)	2x4	2x4	–	–	2x4 (2x6 ◊)	4	4	2 (4 ◊)	2 (4 ◊)	–	–		
	18x8.50-8 6 PR	–	–	–	–	–	–	2x4	2x4	–	–	–	–	–	4	4		
	10.00/75-15.3 10 PR	–	●	●	●	●	●	–	–	–	–	–	–	–	–	–		
Main frame	380 /55 - 17	●	●	–	–	–	–	–	–	–	–	–	–	–	–	–		
	340/55-16	–	◊	◊	◊	◊	◊	–	–	–	–	–	–	–	–	–		
Fully floating suspension		●	●	●	●	●	●	●⁵	●⁵	●	–	–	–	–	–	–		
Drive systems																		
PTO shaft speed	rpm	540	540	540	540	540	540	540	540	540	540	540	540	540	540	540		
Single wide-angle PTO drive shaft		●	●	●	●	●	●	●	●	–	–	–	–	–	●	●		
Convenience																		
Spare wheel 16x6.50-8 10 PR		◊	◊	◊	◊	◊	◊	–	–	–	–	–	–	–	–	–		
Spare wheel 18x8.50-8 6 PR		–	–	–	–	–	–	◊	◊	–	–	–	–	–	–	–		
Wheel weights		◊	◊	◊	◊	◊	◊	–	–	–	–	–	–	–	–	–		
Double wide-angle PTO drive shaft		–	–	–	–	–	–	◊	◊	–	–	–	–	–	–	–		
TWIN function		–	●	●	–	●	–	●	●	–	–	–	–	–	–	–		
Guide wheel		–	–	–	–	–	–	◊	◊	–	◊	◊	◊	–	◊	◊		
Hydraulic folding of swath guard		◊	◊	◊	◊	◊⁷	◊⁷	◊	◊	◊	◊	◊	–	–	◊	◊		
Hydraulic rotor height adjustment		–	–	–	◊	◊	◊	–	–	◊	◊	◊	–	–	–	–		
Warning sign		–	–	–	–	–	–	–	–	◊	◊	◊	◊	◊	◊	◊		
Warning sign with illumination		●	●	●	●	●	●	●	●	◊	◊	◊	◊	◊	◊	◊		
Parallelogram drawbar		–	–	–	–	–	–	●	◊	–	–	–	–	–	◊	◊		
Hydraulic spool valves		1xsa (+ 1xsa⁹)	1xsa (+ 1xsa⁹)	1xsa (+ 1xsa⁹)	1xsa (+ 1xsa⁹)	1xsa	1xsa	1xsa	1xsa	–	–	–	–	–	1xsa	1xsa		
		1xda	1xda	1xda	1xda	(1xda⁷)	(1xda⁷)	1xda	1xda	(2xda⁶⁸)	(2xda⁶⁸)	(2xda⁶⁸)	–	–	(1xda⁶)	(1xda⁶)		

- 1 Swath former cloth guard
- 2 TWIN function (option) with additional swath guard for front rotors

- 3 Swath guard and protective frame folded
- 4 LINER 370 and 320 with single axle
- 5 Rear only

- 6 Hydraulic folding of swath guard
- 7 Hydraulic swath guard adjustment
- 8 Hydraulic rotor height adjustment

● Standard ◊ Option ◻ Available – Not available

CLAAS continually develops its products to meet customer requirements. This means that all products are subject to change without notice. All descriptions and specifications in this brochure should be considered approximate and may include optional equipment that is not part of the standard specifications. This brochure is designed for worldwide use. Please refer to your nearest CLAAS dealer and their price list for local specification details. Some protective panels may have been removed to present the function more clearly in photographs. To avoid any risks, you should never remove these protective panels yourself. In this context, please refer to the relevant instructions in the operator's manual.

● Standard ◊ Option ◻ Available – Not available

LINER central swathers		4000	3600	3100	2900	2800	2700	2600
		Four-rotor swathers		Dual-rotor swathers				
Hitch category		Cat. III	Cat. II	Cat. II	Cat. II	Cat. II	Cat. II	Cat. II
Working width	m (DIN)	12.20–15.00	9.90–12.50	8.70–10.00	8.00–9.00	7.40–8.20	6.80–7.40	6.20–6.80
Swath width ^{1 ca.}	m	1.50–2.60	1.20–2.30	1.50–2.60	1.20–2.40	1.20–2.20	1.20–2.00	1.10–1.80
Transport width								
With tine arms mounted	m	3.00	3.00	2.97	2.97	2.97	2.97	2.97
Transport height								
With tine arms mounted	m	3.99	3.99 ²	4.46	3.99	3.99	3.99	3.99
With tine arms removed	m	3.57	3.40	3.75	3.72	3.47	3.38	3.18
Parking length (transport position)	m	10.16	8.70	6.92	6.53	6.53	5.87	5.87
Rotors	Qty	4	4	2	2	2	2	2
Rotor diameter	m	3.80	3.30	4.20	3.80	3.50	3.20	2.90
Tine arms per rotor	Qty	14	12	14	14	12	12	11
Dual tines per arm set	Qty	4	4	5	4	4	4	4
Tine diameter	mm	9.5	9.5	9.5	9.5	9.5	9	9
PROFIX tine arm bracket		●	●	●	●	●	●	–
Swath-laying position		Centre	Centre	Centre	Centre	Centre	Centre	Centre
Four-wheel rotor chassis		● ³	●	–	● ³	● ³	●	●
Six-wheel rotor chassis		○ ⁴	–	● ³	○	○	○	–
Fully floating suspension		●	●	●	●	●	●	●
Drive systems								
PTO shaft speed	rpm	540	540	540	540	540	540	540
Single wide-angle PTO drive shaft		●	●	●	●	●	●	●
Tyres								
Rotor chassis								
16x6.50-8 10 PR		4x4	4x4	2x6	2x4	2x4	2x4	2x4
Main frame								
10.00/75-15.3 10 PR		–	–	–	–	2	2	2
500/55-20		–	○	–	–	–	–	–
620/40 R 22.5		2	○	–	–	–	–	–
380 /55 - 17		–	2	2	2	○	–	–
Weight approx.	kg	5480	4600	2880	2250	2050	1900	1600
Convenience								
Spare wheel 16x6.50-8 10 PR		○	○	○	○	○	○	○
Wheel weights		–	–	●	○	○	○	–
Single-rotor lifting function (three-way valve)		–	–	○	○	○	○	○
Electrohydraulic individual rotor lift		●	●	○	○	○	–	–
Electrohydraulic rotor height adjustment		○	○	○	○	○	–	–
LED working lights		○	○	–	–	–	–	–
		–	1xsa	1xsa	1xsa	1xsa	1xsa	1xsa
Hydraulic spool valves		1xsa + fR or LS	1xsa + fR or LS	1xda	1xda	1xda	–	–

- 1 Depending on forage conditions and engine speed
- 2 For tyre variant 500/55-20
- 3 Front lateral suspension
- 4 For rear pair of rotors

● Standard ○ Option □ Available – Not available



Ensuring a better **harvest.**

CLAAS UK
Saxham
Bury St. Edmunds
Suffolk
IP28 6QZ
Tel 01284 763100
claas.co.uk
info-uk@claas.com

365FarmNet enables you to manage your entire agricultural business by means of a single, non-proprietary software solution. Interfaces to intelligent applications created by partners in the agricultural sector offer expert support for your business 365 days a year. CLAAS is a 365FarmNet partner.

