

EDGE LINE
RAISE YOUR GAME



ARTICULATED CRANES WITH ULTIMATE PRECISION AND LIFTING CAPACITY

HC 213



RAISE YOUR GAME HYVA PERFORMANCE

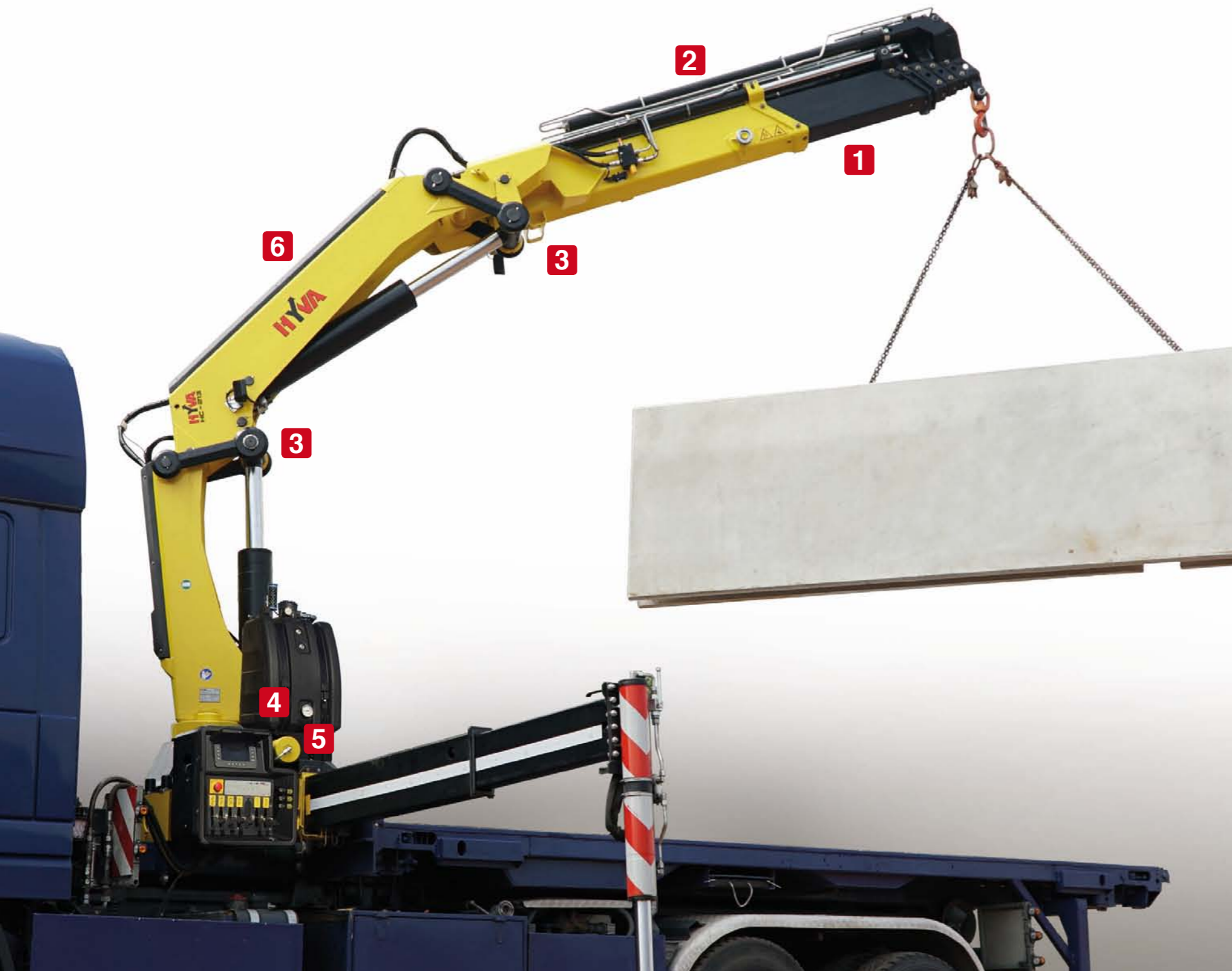

TOP SOLUTIONS

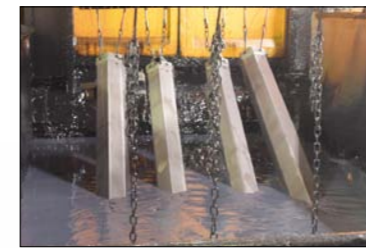

1 TPP

- **Top protection painting** - Top quality cataphoresis treatment and paint process on all crane components ensures higher value retention and durability.
- Bolts and nuts protected by Geomet® treatment: 890% more resistance against corrosion.

Top quality protection for harsh environment

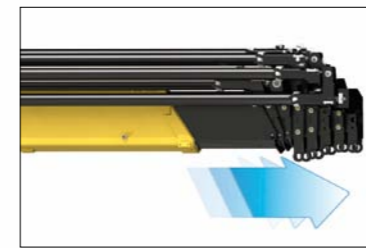

2 EES

- **Extra Extension Speed** - The market is always demanding more speed along with the highest possible safety. EES is the answer. Through the use of a specially designed counterbalance valve, this system increases the extension speed without affecting the crane's safety.

Save time, precise work, increase efficiency



3 LAS

- **Liftrod Articulating System** - Joins forged double linkages on the column and second boom. Its design raises the mechanical advantage of the articulation to provide consistent force through all working angles.

Precision and versatility for all working positions

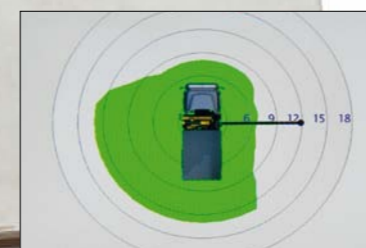

4 DLD

- **Dynamic Load Diagram** - After the stabilization, operator can select the load to be lifted. Display shows the permitted crane outreach based on the stability and the load selected.

Crane lifting capacity always under control in all stabilizer positions



5 MT

- **Magic Touch System** - Allows the driver to open the crane from transport position to working position and back by pushing a single lever on the radio transmitter (or a button on the display).

Crane Automatic folding/unfolding



6 SDS

- **Smooth Descent System** - Uses a special counterbalance valve to reduce boom oscillation, the result for the user is incredible precision in unloading operations.

Control and precision of the movement

TECHNICAL SOLUTIONS TO RAISE RELIABILITY AND SAFETY

Safety first: always stable



- More than 40 stabilizer configurations to ensure safe positioning of the truck in all ground conditions.
- Automatic turning stabilizers are the smart solution. Equipped with a double effect cylinder, they provide effortless movement.

Working flexibility: performance in any situation



- Negative angle between first/second boom produces the most versatile crane structure available. The result is working flexibility - easier access to confined and low ceiling spaces.

Electronics in mind: guaranteed in all conditions



- All electrical components have IP69K enclosures which offer complete protection against water jet and dust penetration providing higher durability and less down time.

Safety Performance Efficiency



H3XL

With a 3" TFT display and ergonomic keyboard, the crane operator can select optimum functional parameters. The system controls the stability with 2-step beam outreach monitoring and continuous slewing control.



H4XL

A 7" colour display with integrated keyboard gives the operator a higher level of awareness of the crane operation and allows selection of the best parameters for effective use. The system detects the exact position of the beams and proportionally calculates the stability.

SMART AND USER-FRIENDLY CONTROLS

Control station distinguished by operator comfort and user-friendly interface derived from dedicated ergonomic and user preference studies

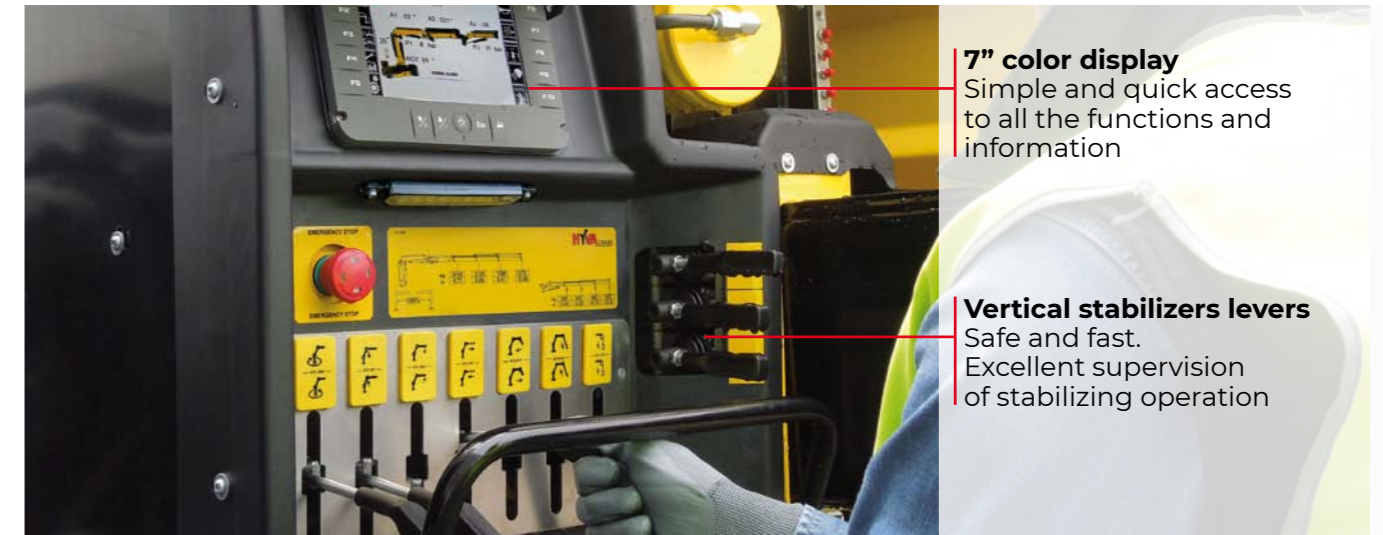

7" color display
Simple and quick access to all the functions and information

Vertical stabilizers levers
Safe and fast. Excellent supervision of stabilizing operation

OUR INNOVATIONS ARE CHANGING THE GAME

Solutions that are the result of smart engineering

DLD DYNAMIC LOAD DIAGRAM



This system, a first on truck-mounted articulated cranes, optimises stabilization, makes crane operation safer and more efficient and allows the driver to verify in advance the crane lifting capacity based on truck stability. A graphic display shows the outreach available for the load selected and the actual boom slewing position.

MT MAGIC TOUCH



This easy-to-use function improves driver attention, promotes safety, saves time and increases productivity. Once the truck is stabilized, a graphic display allows the driver to automatically unfold the crane to a working position and fold the crane from any position to transport position.

Wide range Radio selection



Hetronic NOT CE



Hetronic CE Basic



Scanreco



Hetronic CE Graphic



distributor
Danfoss

A TEAM OF SKILLED AND CARING SPECIALISTS

Easy installation and smart calibration cranes, combined with a high level of service, make Hyva the best partner for your business - all over the world



TECHNICAL INFORMATION HC213

Dimensions (mm)

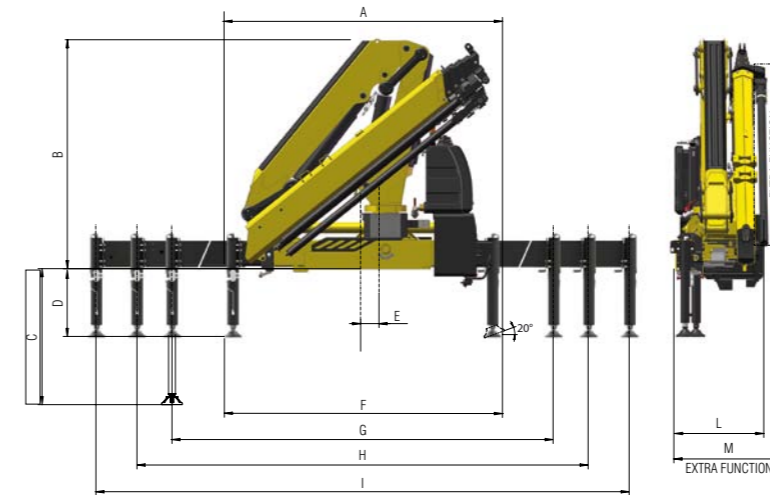

	E2	E3	E4	E5	E6	E3J3	E4J3	E5J2
A	2500	2500	2500	2500	2500	2500	2500	2500
B	2300	2300	2300	2300	2300	2670	2600	2550
C	1348	1348	1348	1348	1348	1348	1348	1348
D	666	666	666	666	666	666	666	666
E	150	150	150	150	150	150	150	150
F	2520	2520	2520	2520	2520	2520	2520	2520
G	4860	4860	4860	4860	4860	4860	4860	4860
H	5500	5500	5500	5500	5500	5500	5500	5500
I	7420	7420	7420	7420	7420	7420	7420	7420
L	930	930	930	930	930	1050	1050	1050
M	1050	1050	1050	1120	1120	-	-	-

Load diagrams

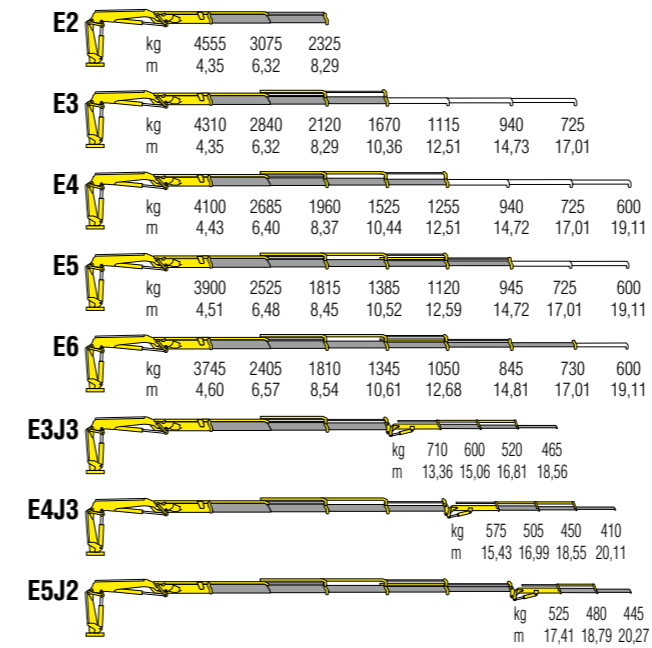

Standard features

Designed in accordance with EN12999

Design class: HC1-HD4

- Cross controls
- Load limiting device
- LCS Lift Control System
- Flanged valves
- Oil tank
- Manually extendable stabilizers
- Fixed stabilizer cylinders
- Swivel stabilizer foot
- Centralized greasing system
- EES Extra Extension Speed
- SDS Smooth Descent System
- LAS Liftrod Articulating System
- H3XL Crane control system (CE)

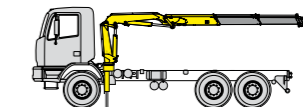

Recommended truck
M.T.T. ton 19 - G.V.W. ton 19

ONE CRANE, MANY APPLICATIONS

Thanks to the extensive range of accessories and attachments



Building



Construction



Energy



Environment



Gardening



Logistics



Maintenance



Mining



Oil&Gas



Rental

Technical specifications - EN12999 - HC1-HD4

	E2	E3	E4	E5	E6	E3J3	E4J3	E5J2
Lifting Moment	tm	19,8	18,7	18,2	17,6	17,2	15,0	14,9
Slewing Angle	°	415	415	415	415	415	415	415
Working pressure	bar	320	310	310	310	310	-	-
Oil tank capacity	l	130	130	130	130	130	130	130
Max Oil flow	l/min	70	70	70	70	70	70	70
Max lifting height	m	12,0	14,1	16,2	18,4	20,7	22,2	23,9
Standard crane weight	kg	2475	2625	2775	2895	2990	3285	3170

130 countries
3,000 employees
25,000 customers
37 subsidiaries
12 production facilities



Hyva is a leading provider of innovative and highly efficient transport solutions for commercial vehicles used in transport, construction, mining, materials handling and environmental service industries.

Founded in 1979 in the Netherlands, the company has a global presence with 37 fully owned subsidiaries, extraordinary service coverage and 12 manufacturing facilities in Brazil, China, Europe and India.

For more information on Hyva, please visit www.hyva.com

or follow us on:



Hyva Holding B.V.
Antonie van Leeuwenhoekweg 37
2408 AK Alphen aan den Rijn
The Netherlands
Telephone: +31 (0)172 - 42 35 55
Telefax: +31 (0)172 - 42 08 80
info@hyva.com
www.hyva.com



**Quality and
environmental certified**

DEALER STAMP