

**COMPANY QUALITY
SYSTEM QUALITY**

Certified in accordance with the
ISO 9001 norms and subject to
voluntary and periodical inspections



GORMAGH

49000 E - 51800 E



49000-E4

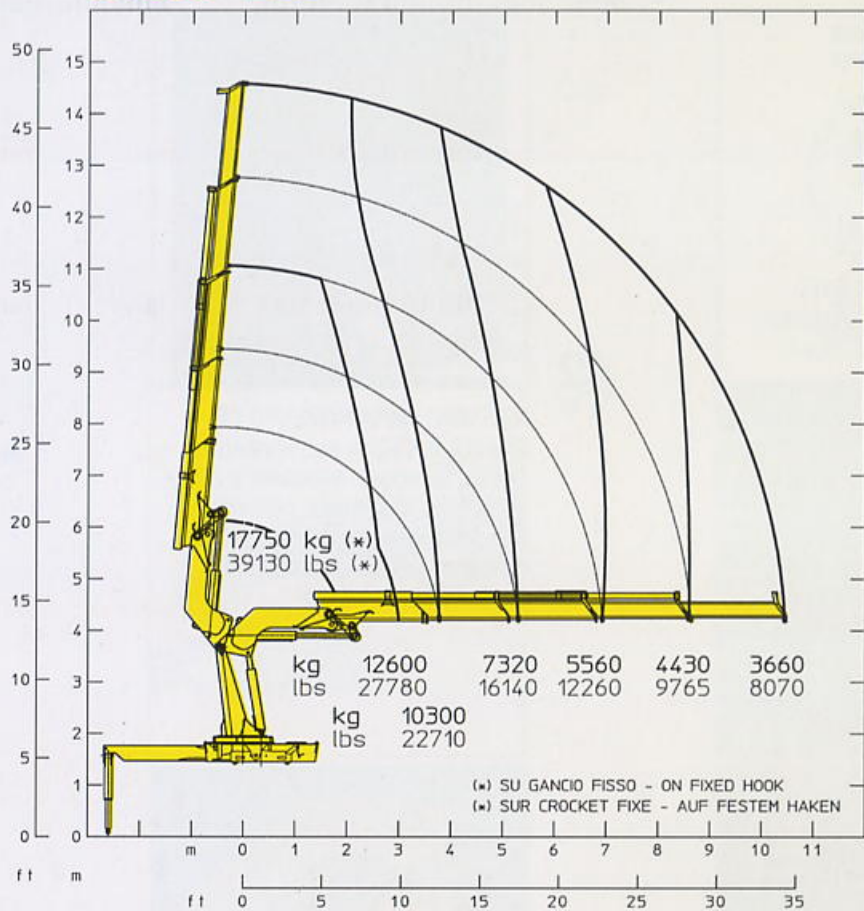

49000-E6

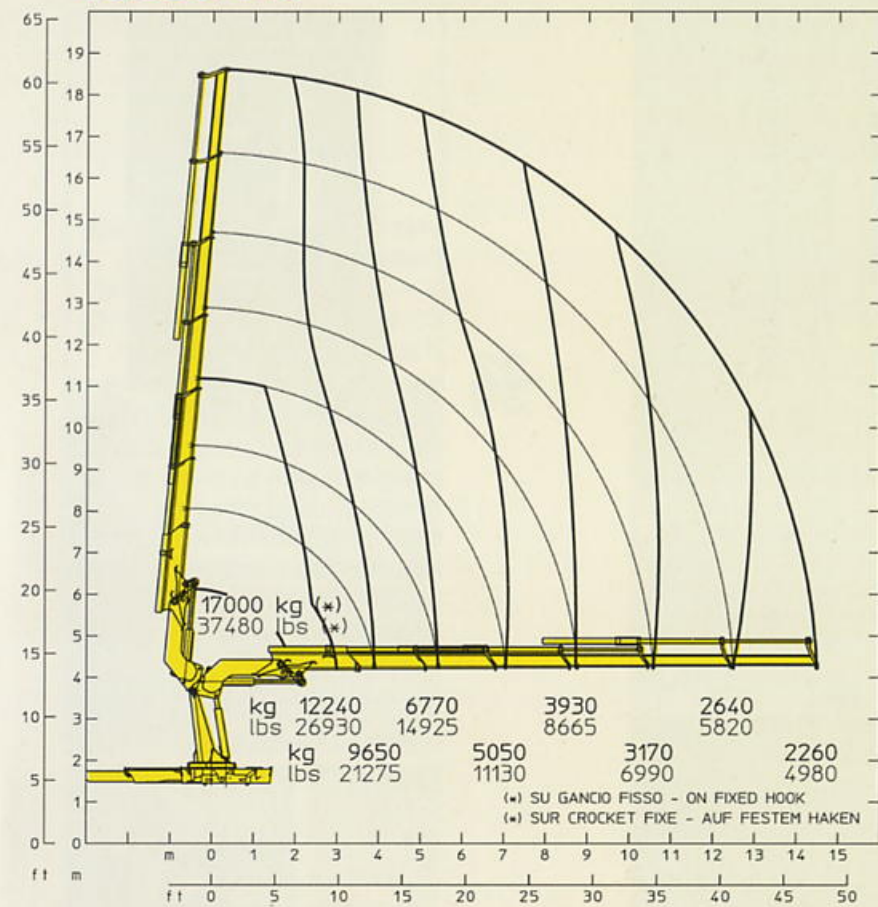

STANDARD

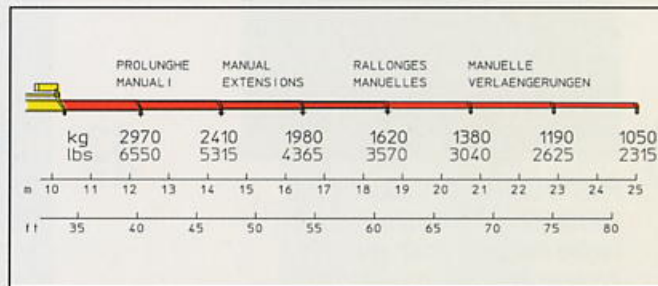
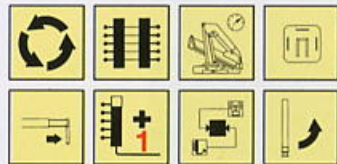

OPTIONAL



Momento statico al perno torretta (49000)	49000 daN · m	354500 lb · ft
Sbraccio idraulico	10.30 m	33' 10"
Coppia di rotazione	4200 daN · m	30400 lb · ft
Tempo di rotazione	63 sec./360°	63 sec./360°
Uscita stabilizzatori	2420 + 2420 mm	7' 10" + 7' 10"
Larghezza stabilizzatori	7138 mm	23' 5"
Lunghezza gru	1302 mm	4' 3"
Larghezza gru	2500 mm	8' 2"
Altezza gru	2440 mm	8'
Peso gru (senza olio)	5070 kg	11180 lbs
Portata pompa	80 lit/min	21 us gal/min
Pressione di lavoro	275 bar	3910 psi
Capacità serbatoio olio	250 lit	66 us gal

STANDARD

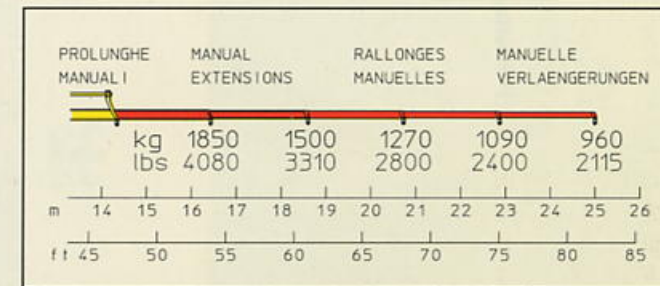
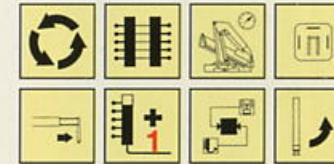

OPTIONAL



Momento statico al perno torretta (gru 51800 A.S.C.)	49000 daN · m	354500 lb · ft
Sbraccio idraulico	14.34 m	47' 1"
Coppia di rotazione	4200 daN · m	30400 lb · ft
Tempo di rotazione	63 sec./360°	63 sec./360°
Uscita stabilizzatori	2420 + 2420 mm	7' 11" + 7' 11"
Larghezza stabilizzatori	7138 mm	23' 5"
Lunghezza gru	1302 mm	4' 3"
Larghezza gru	2500 mm	8' 2"
Altezza gru	2440 mm	8'
Peso gru (senza olio)	5810 kg	12810 lbs
Portata pompa	80 lit/min	21 us gal/min
Pressione di lavoro	275 bar	3910 psi
Capacità serbatoio olio	250 lit	66 us gal

49000-E8

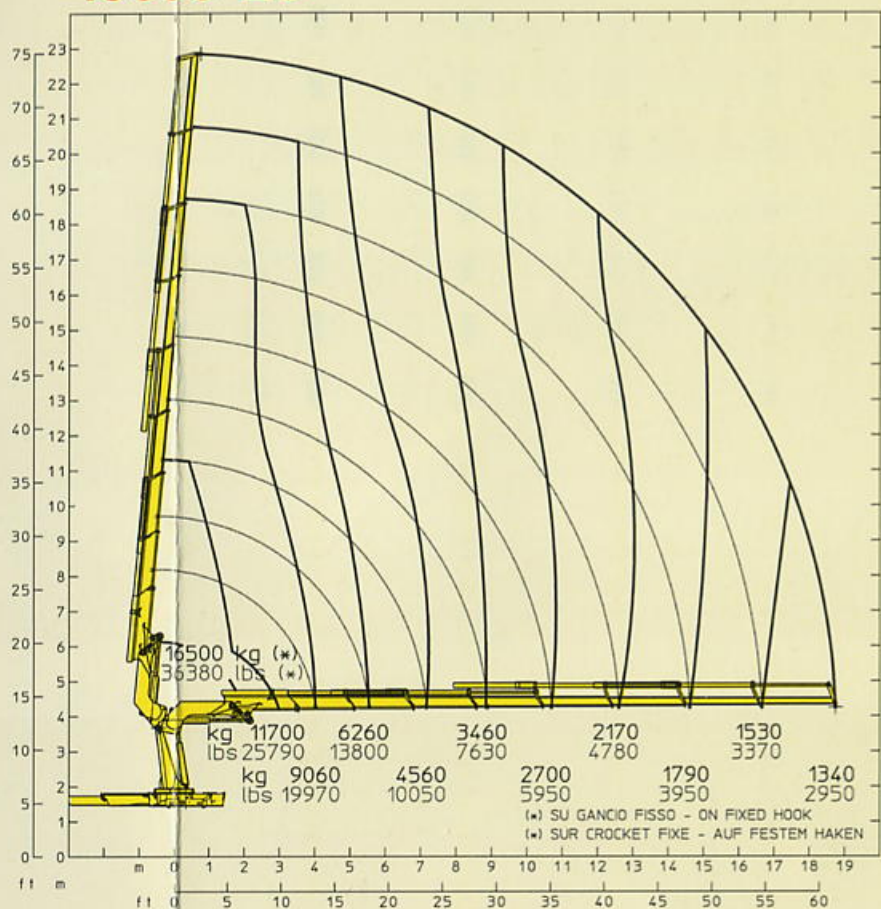

STANDARD

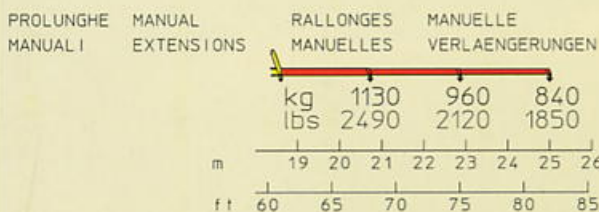

OPTIONAL



Momento statico al perno torretta (gru 49000)	49000 daN · m	354500 lb · ft
Sbraccio idraulico	18.59 m	60' 12"
Coppia di rotazione	4200 daN · m	30400 lb · ft
Tempo di rotazione	63 sec./360°	63 sec./360°
Uscita stabilizzatori	2420 + 2420 mm	7'11" + 7'11"
Larghezza stabilizzatori	7138 mm	23' 5"
Lunghezza gru	1302 mm	4' 3"
Larghezza gru	2500 mm	8' 2"
Altezza gru	2440 mm	8'
Peso gru (senza olio)	6300 kg	13890 lbs
Portata pompa	80 lit/min	21 us gal/min
Pressione di lavoro	275 bar	3910 psi
Capacità serbatoio olio	250 lit	66 us gal

49000-E6-F134

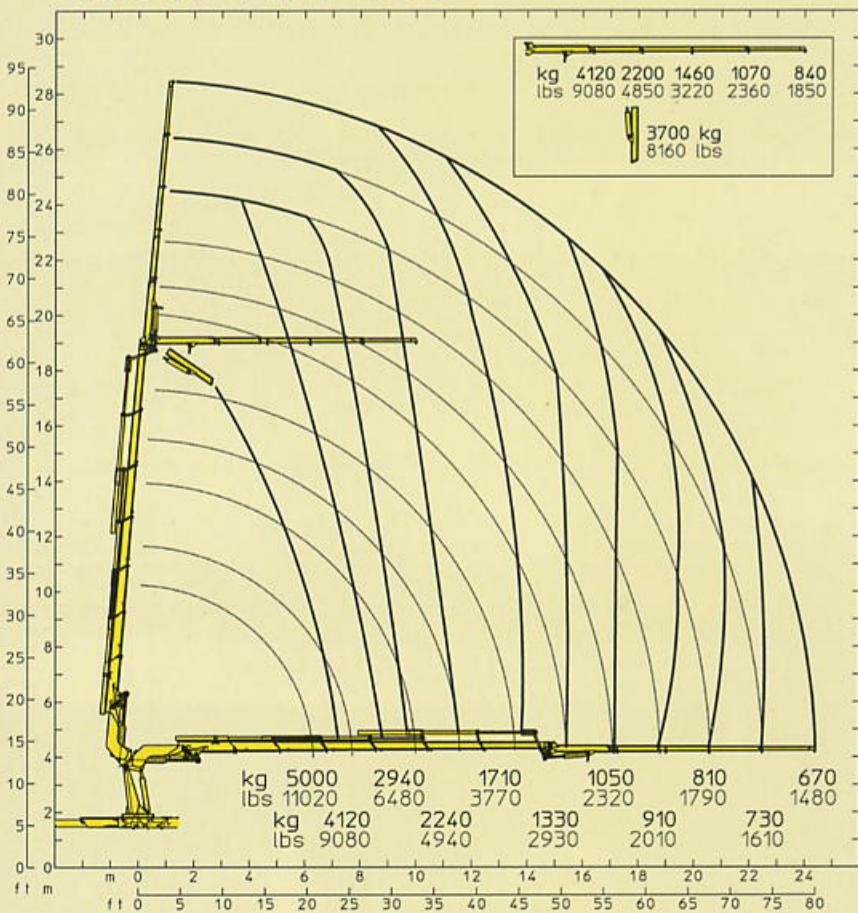

49000-E8-F64

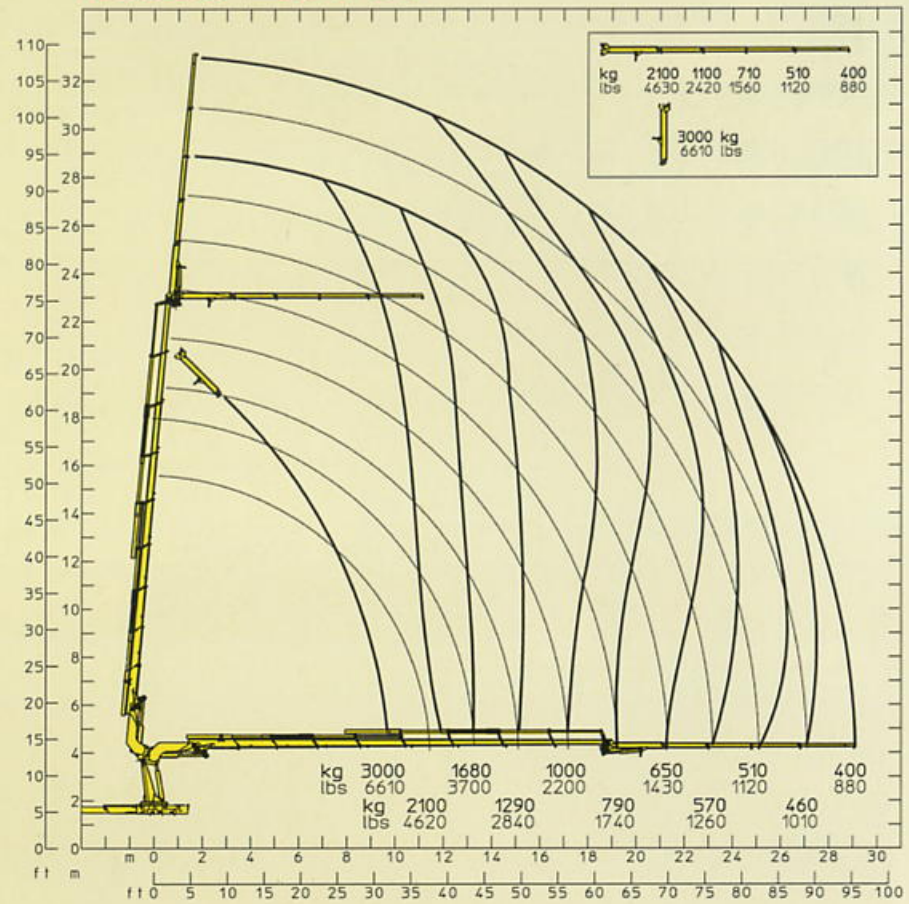

STANDARD

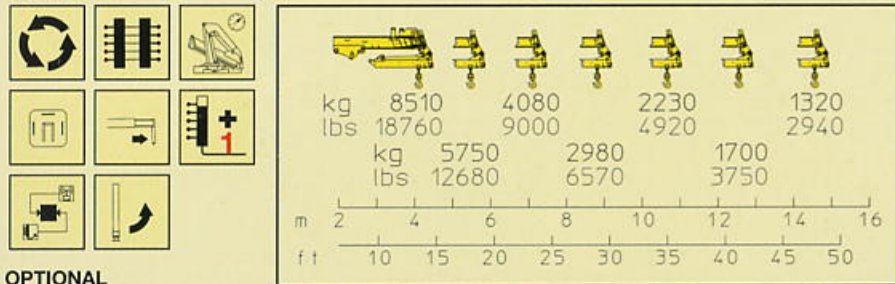

OPTIONAL



STANDARD

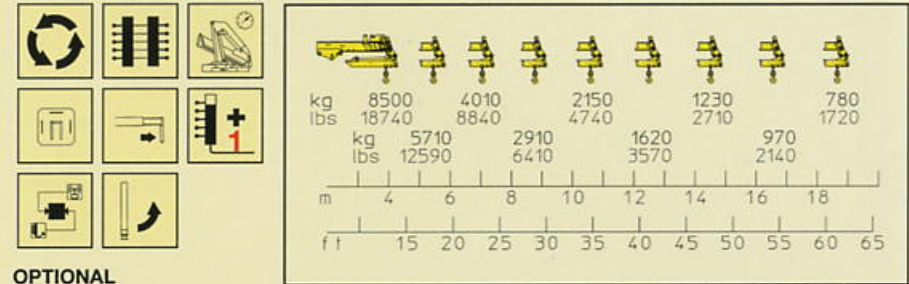

OPTIONAL



Momento statico al perno torretta (gru 51800 A.S.C.)	49000 daN · m	254500 lb · ft
Sbraccio idraulico	24,25 m	79' 7"
Coppia di rotazione	4200 daN · m	30400 lb · ft
Tempo di rotazione	63 sec./360°	63 sec./360°
Uscita stabilizzatori	2420 + 2420 mm	7'11" + 7'11"
Larghezza stabilizzatori	7138 mm	23' 5"
Lunghezza gru	1302 mm	4' 3"
Larghezza gru	2500 mm	8' 2"
Altezza gru	2440 mm	8'
Peso gru (senza olio)	7095 kg	15642 lbs
Portata pompa	80 lit/min	21 us gal/min
Pressione di lavoro	275 bar	3910 psi
Capacità serbatoio olio	250 lit	66 us gal

Momento statico al perno torretta (gru 49000)	49000 daN · m	354500 lb · ft
Sbraccio idraulico	28,64 m	93' 12"
Coppia di rotazione	4200 daN · m	30400 lb · ft
Tempo di rotazione	63 sec./360°	63 sec./360°
Uscita stabilizzatori	2420 + 2420 mm	7'11" + 7'11"
Larghezza stabilizzatori	7138 mm	23' 5"
Lunghezza gru	1302 mm	4' 3"
Larghezza gru	2500 mm	8' 2"
Altezza gru	2440 mm	8'
Peso gru (senza olio)	7210 kg	15895 lbs
Portata pompa	80 lit/min	21 us gal/min
Pressione di lavoro	275 bar	3910 psi
Capacità serbatoio olio	250 lit	66 us gal

51800-E4 PLUS

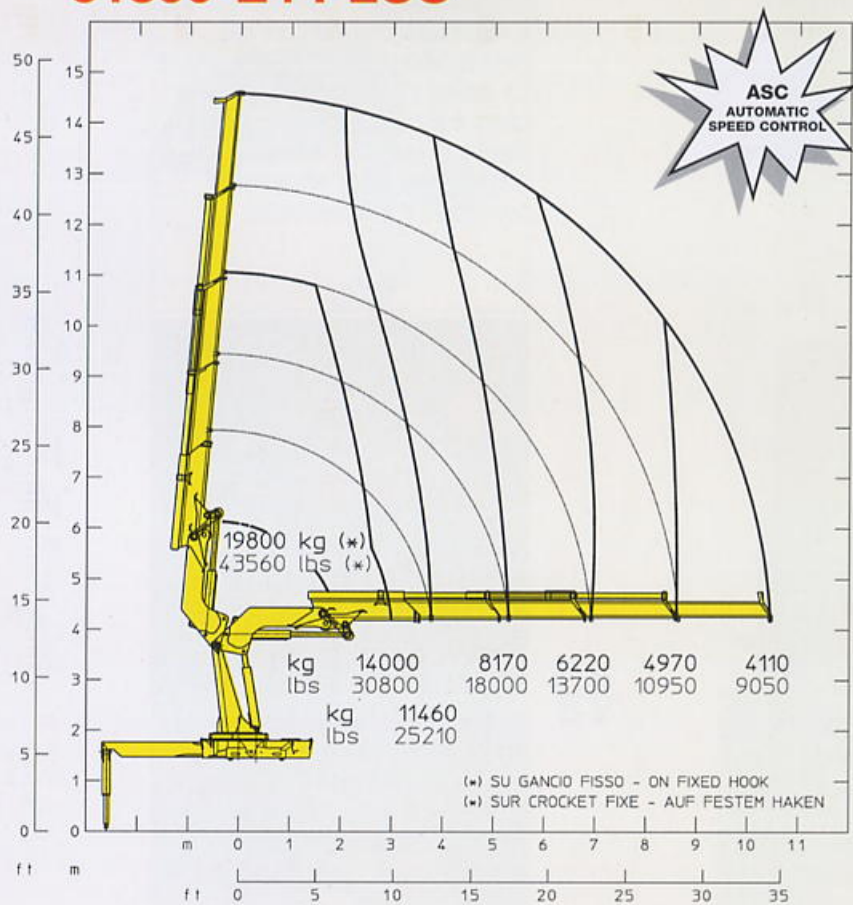

STANDARD

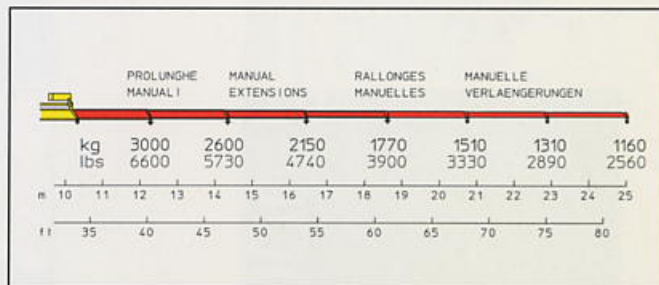
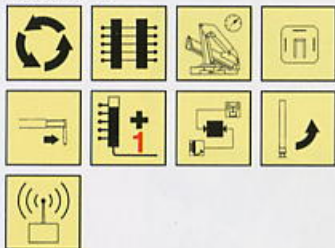

OPTIONAL



Momento statico al perno torretta (49000)	53900 daN · m	389200 lb · ft
Sbraccio idraulico	10.30 m	33' 10"
Coppia di rotazione	4200 daN · m	30400 lb · ft
Tempo di rotazione	63 sec./360°	63 sec./360°
Uscita stabilizzatori	2420 + 2420 mm	7' 10" + 7' 10"
Larghezza stabilizzatori	7138 mm	23' 5"
Lunghezza gru	1302 mm	4' 3"
Larghezza gru	2500 mm	8' 2"
Altezza gru	2440 mm	8'
Peso gru (senza olio)	5070 kg	11180 lbs
Portata pompa	80 lit/min	21 us gal/min
Pressione di lavoro	275 bar	3910 psi
Capacità serbatoio olio	250 lit	66 us gal

51800-E6 PLUS

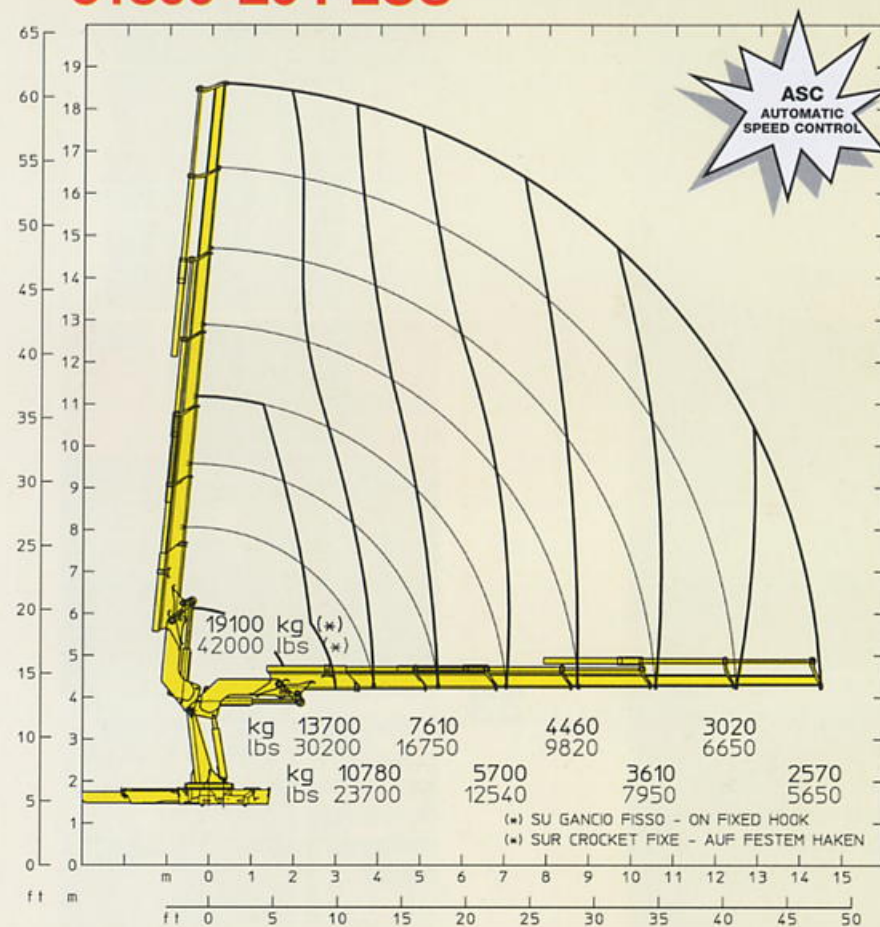

STANDARD

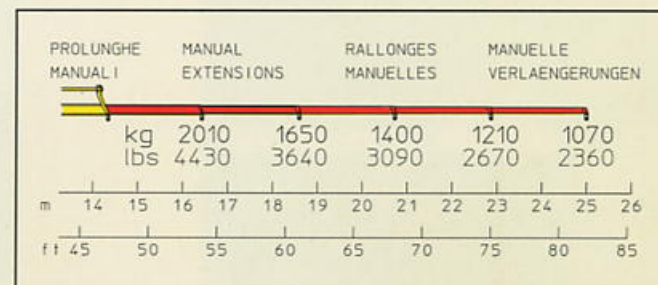
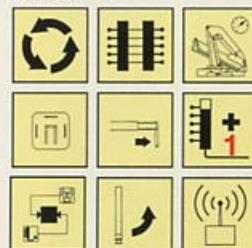

OPTIONAL



Momento statico al perno torretta (gru 51800 A.S.C.)	53900 daN · m	389200 lb · ft
Sbraccio idraulico	14.34 m	47' 1"
Coppia di rotazione	4200 daN · m	30400 lb · ft
Tempo di rotazione	63 sec./360°	63 sec./360°
Uscita stabilizzatori	2420 + 2420 mm	7'11" + 7'11"
Larghezza stabilizzatori	7138 mm	23' 5"
Lunghezza gru	1302 mm	4' 3"
Larghezza gru	2500 mm	8' 2"
Altezza gru	2440 mm	8'
Peso gru (senza olio)	5810 kg	12810 lbs
Portata pompa	80 lit/min	21 us gal/min
Pressione di lavoro	275 bar	3910 psi
Capacità serbatoio olio	250 lit	66 us gal

51800-E8 PLUS

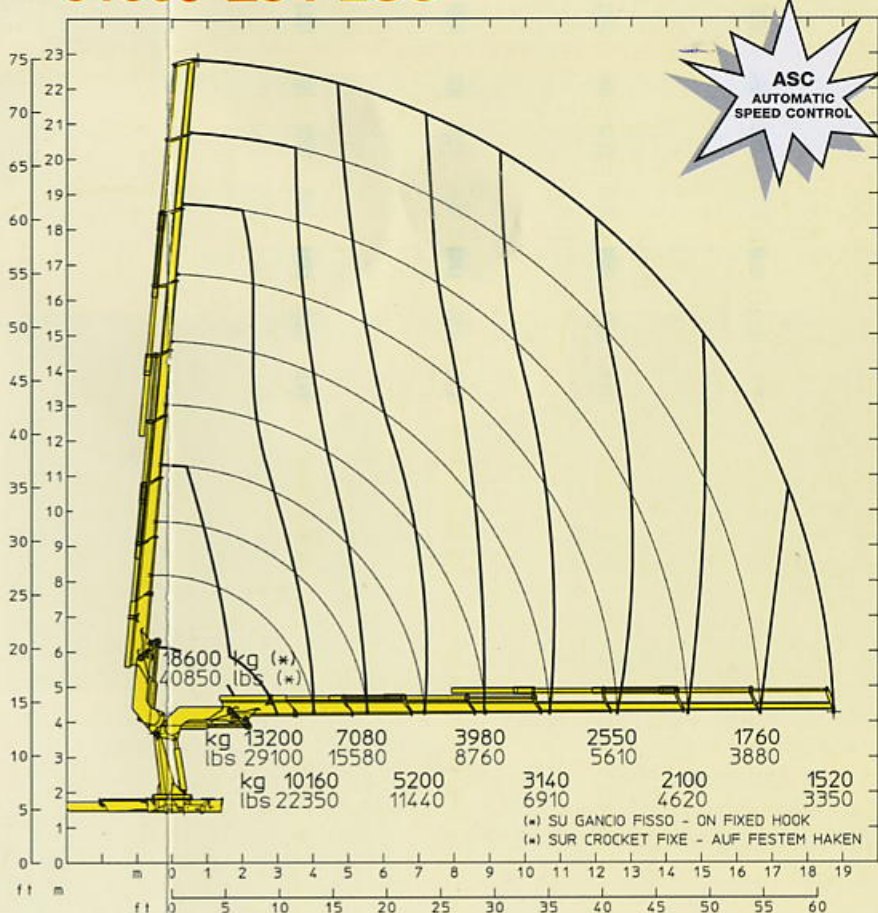

STANDARD



PROLUNGHE
MANUAL I

MANUAL
EXTENSIONS

RALLONGES
MANUELLES

MANUELLE
VERLAENGERUNGEN

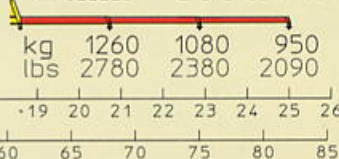

OPTIONAL



Momento statico al perno torretta (gru 49000)	53900 daN · m	389200 lb · ft
Sbraccio idraulico	18.59 m	60' 12"
Coppia di rotazione	4200 daN · m	30400 lb · ft
Tempo di rotazione	63 sec./360°	63 sec./360°
Uscita stabilizzatori	2420 + 2420 mm	7'11" + 7'11"
Larghezza stabilizzatori	7138 mm	23' 5"
Lunghezza gru	1302 mm	4' 3"
Larghezza gru	2500 mm	8' 2"
Altezza gru	2440 mm	8'
Peso gru (senza olio)	6300 kg	13890 lbs
Portata pompa	80 lit/min	21 us gal/min
Pressione di lavoro	275 bar	3910 psi
Capacità serbatoio olio	250 lit	66 us gal

51800-E6-F134 PLUS

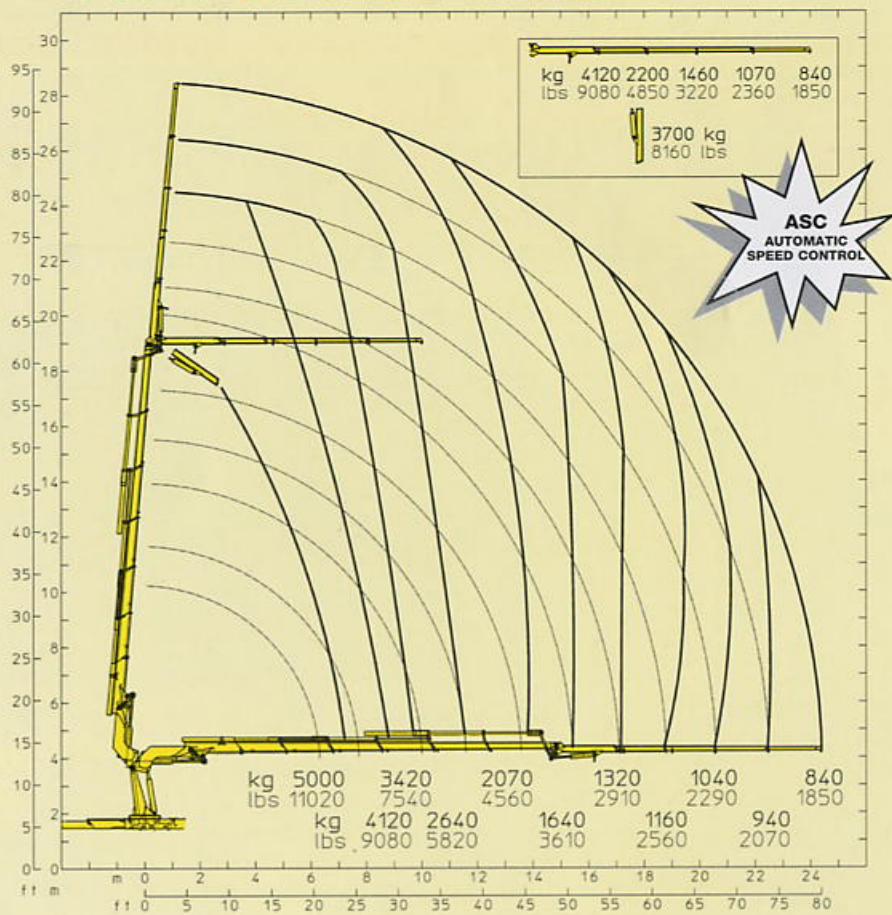

51800-E8-F64 PLUS

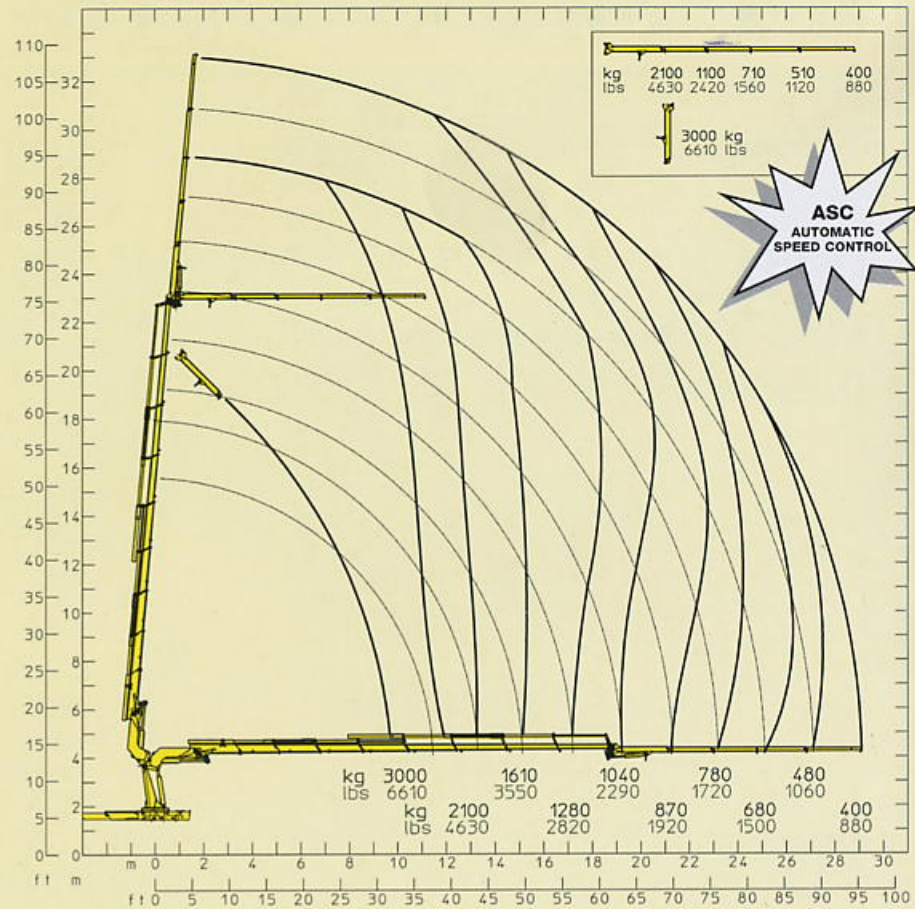

STANDARD

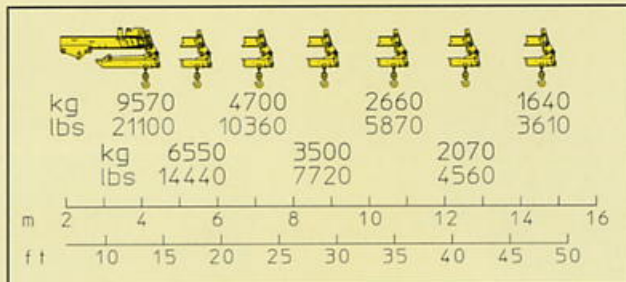

OPTIONAL



STANDARD

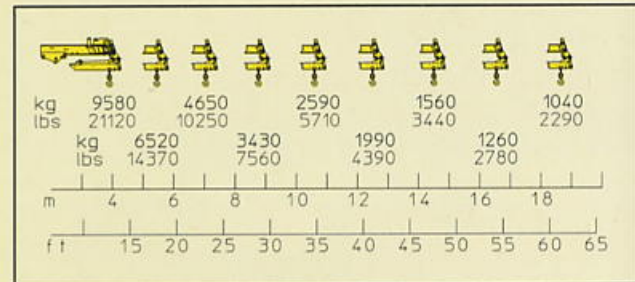

OPTIONAL

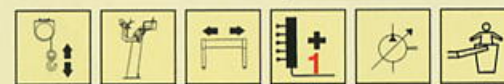

Momento statico al perno torretta (gru 51800 A.S.C.)	53900 daN · m	389200 lb · ft
Sbraccio idraulico	24,25 m	79' 7"
Coppia di rotazione	4200 daN · m	30400 lb · ft
Tempo di rotazione	63 sec./360°	63 sec./360°
Uscita stabilizzatori	2420 + 2420 mm	7'11" + 7'11"
Larghezza stabilizzatori	7138 mm	23' 5"
Lunghezza gru	1302 mm	4' 3"
Larghezza gru	2500 mm	8' 2"
Altezza gru	2440 mm	8'
Peso gru (senza olio)	7095 kg	15610 lbs
Portata pompa	80 lit/min	21 us gal/min
Pressione di lavoro	275 bar	3910 psi
Capacità serbatoio olio	250 lit	66 us gal

Momento statico al perno torretta (gru 51800 A.S.C.)	53900 daN · m	389200 lb · ft
Sbraccio idraulico	28,64 m	93' 12"
Coppia di rotazione	4200 daN · m	30400 lb · ft
Tempo di rotazione	63 sec./360°	63 sec./360°
Uscita stabilizzatori	2420+2420 mm	7'11" + 7'11"
Larghezza stabilizzatori	7138 mm	23' 5"
Lunghezza gru	1302 mm	4' 3"
Larghezza gru	2500 mm	8' 2"
Altezza gru	2440 mm	8'
Peso gru (senza olio)	7210 kg	15860 lbs
Portata pompa	80 lit/min	21 us gal/min
Pressione di lavoro	275 bar	3910 psi
Capacità serbatoio olio	250 lit	66 us gal

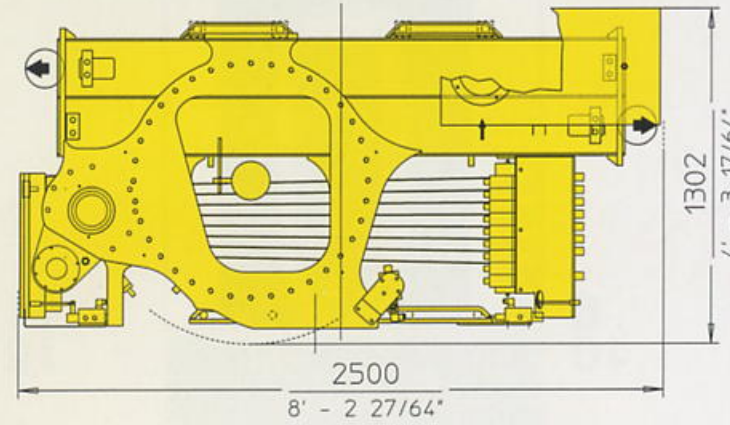
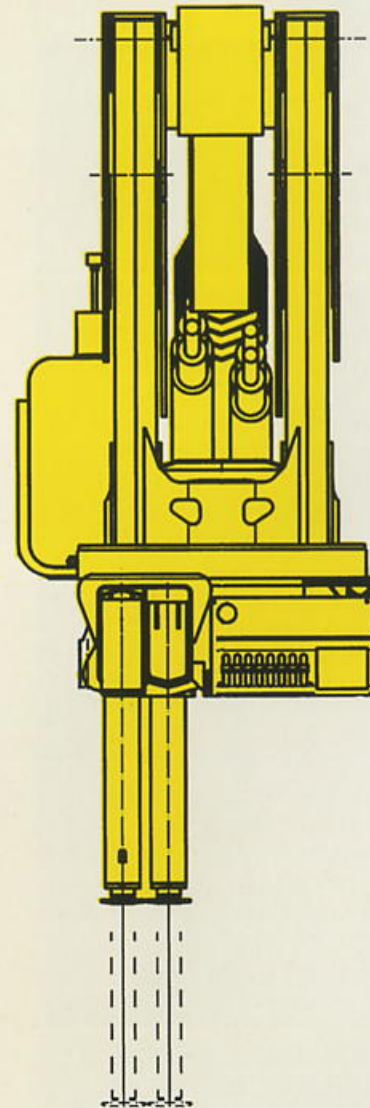
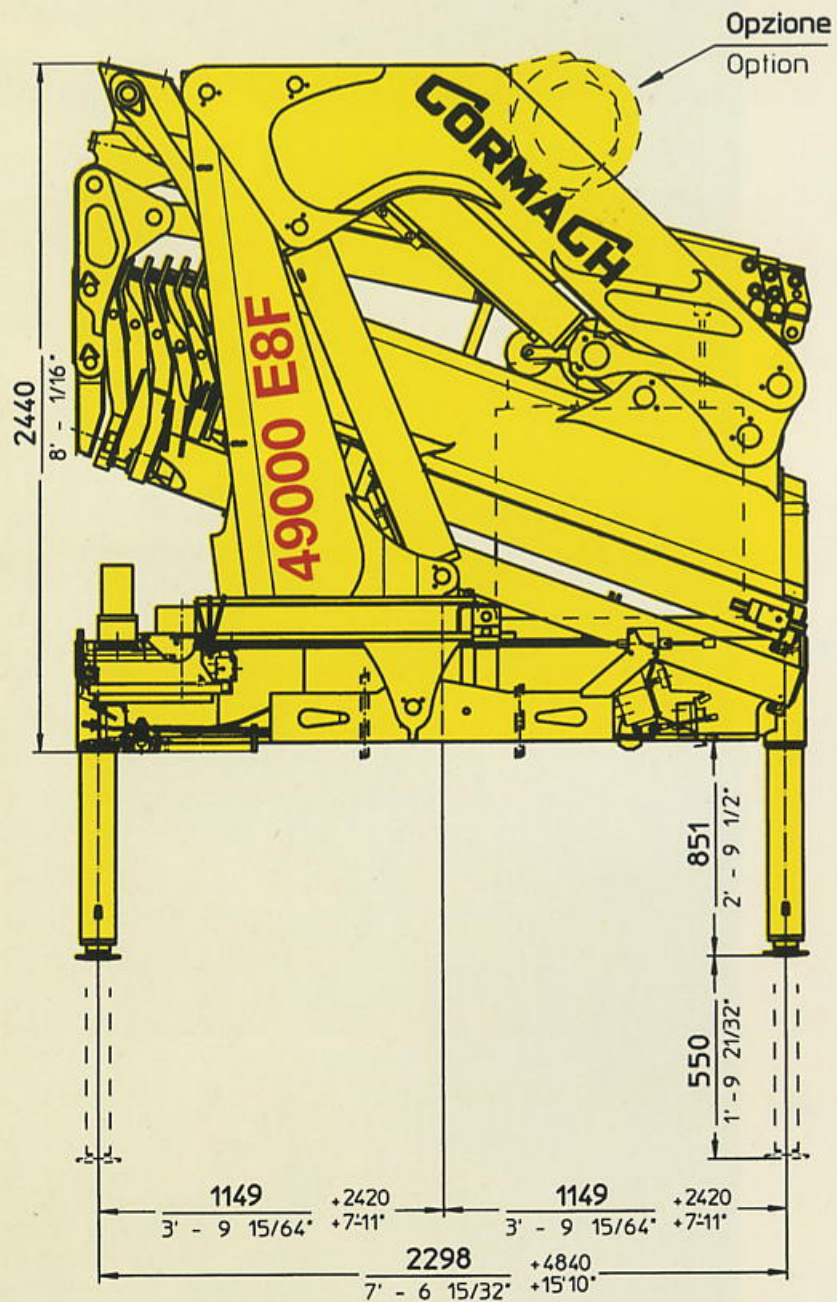

STANDARD

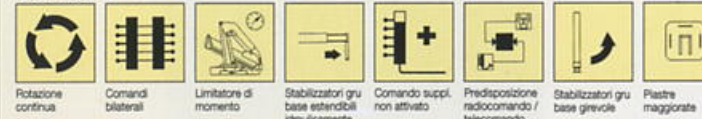

OPTIONAL



GORMAGH

Cormach s.r.l. - Via Madonnina, 27 - C.P. 199 - 25018 MONTICHIARI (BS) - ITALY
Tel. 0039.030.9656811 - Telefax 0039.030.9656846.7.8
E-mail: info@cormach.com - Web: <http://www.cormach.com>

A fronte di una continua ricerca tecnologica i dati possono cambiare senza preavviso. Contattare il nostro Ufficio Commerciale per ulteriori informazioni.
Because of continuous technology research data can change without notice. Please, contact our Commercial Dept. for further information.
A cause de une continue recherche technologique les données peuvent changer sans preavis. Contacter notre Bureau Commercial pour des autres informations.
Irrtum und technische Änderung vorbehalten masse und gewichte unverbindlich. Unser Vertrieb erteilt Ihnen gerne weitere Auskünfte. Bitte rufen Sie uns an.
Debido a los continuos avances tecnológicos los datos pueden variar sin notificación previa. Para más información rogamos contacten nuestro Departamento Comercial.