

ATLAS

SINCE 1919



LADEKRAM AK 292N



LOADER CRANE AK 292N



**WIRTSCHAFTLICH,
FLEXIBEL, STARK
ECONOMICAL,
FLEXIBLE, STRONG**



max: 6220 kg

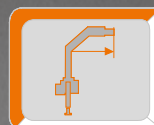

max: 21,00 m



max: 310 bar

WWW.ATLASGMBH.COM



Unsere Unternehmensabläufe sind zertifiziert nach DIN EN ISO 9001 : 2008.
Our business processes are certified to DIN EN ISO 9001 : 2008.

ATLAS S_{LC} SYSTEM



Kranabsicherung durch SLC-System
(Sicherheits- Last-Control-System)
ohne Not-Aus-Einrichtung,

Safety devices by SLC-System
(Safety- Load-Control-System)
Without emergency stop device

WERKZEUGE Tools



Mehrschalengreifer
Orange Peel
Grapple



Steinstapelzange
Brick Stack
Grapples



Greifer
Grabber



Greiferkopfstück,
schnell
montierbar.
Quickly
mountable grab
head piece.



Krangabel
Pallet Fork

AUSSTATTUNGSMÖGLICHKEITEN EQUIPMENT OPTIONS



Ölbehälter
Oil Tank



Schlauchtrommel
für gutes Spulen der
Schläuche.
Hose reel for good coils
of hoses.



Innenliegende
Schlauchführung,
guter Schutz für die
Schläuche.
Internal hose routing,
good protection for
hoses.

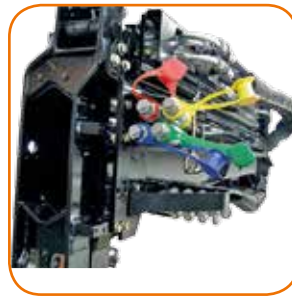

Schnellverschluss-
kupplungen zum
schnellen Wechseln von
Werkzeugen.
Quick-release couplings
for quick tool changes.



AVAILABLE & COST EFFECTIVE

AUSSTATTUNGSMÖGLICHKEITEN EQUIPMENT OPTIONS



ABSTÜTZUNGEN

ATLAS bietet unterschiedliche Ausführungsvarianten entsprechend der erforderlichen Abstützsituationen. Die ATLAS-typischen Vierkantabstützungen gewährleisten höchste Standsicherheit.

SUPPORTING LEGS

ATLAS proposes various design versions depending on the requirements for support in the relevant situation. The ATLAS typical square outriggers guarantee the highest level of stability.



Zusatzabstützträger
Additional outriggers



AUSSTATTUNGSMÖGLICHKEITEN EQUIPMENT OPTIONS



Stützfuß, anschraubbar.
Screw-on supporting leg.



Stützfuß automatisch schwenkbar,
über Ritzel und Zahnstange.
Support leg automatically slewed
through rack and pinion.



Stützfuß, anschraubbar.
Screw-on supporting leg.



Manuelle 180° schwenkbare Zylinderrohrabstützung.
Schwenkunterstützung für leichtes schwenken, durch eine
Gasdruckfeder.

Manually operated 180° swivelling cylinder-tube support.
Swivable support for easy swivel by a pneumatic spring.



AVAILABLE & COST EFFECTIVE

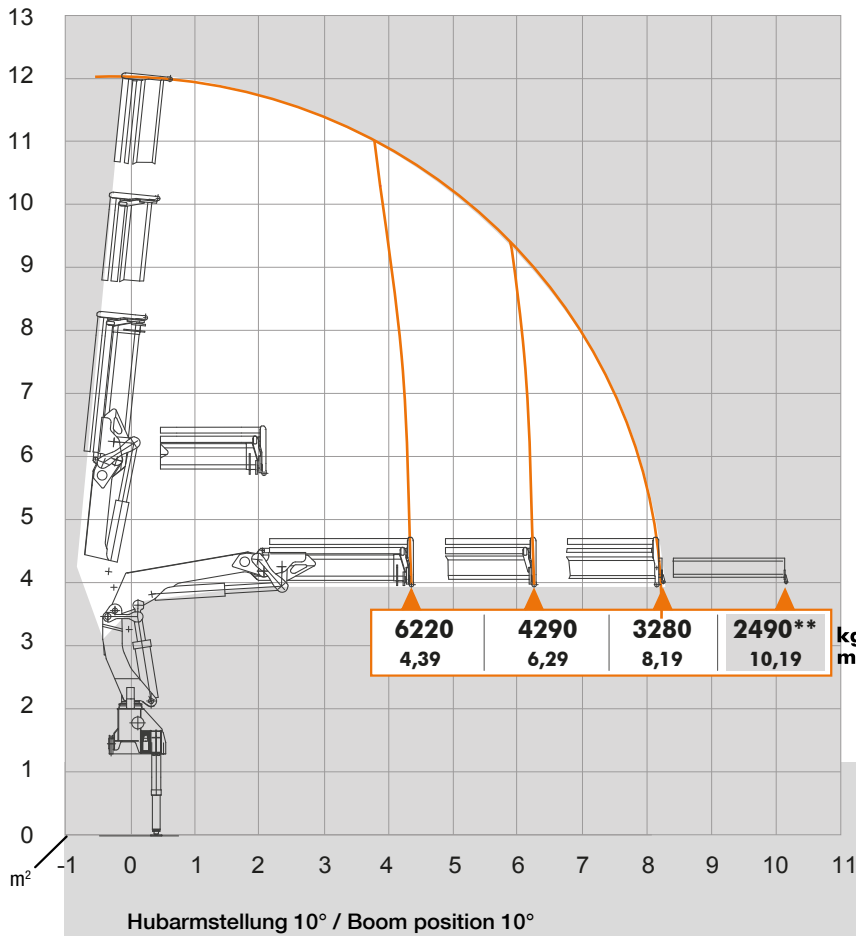

AK 292N A2-8,2/2/V102

Kg - Traglast/lifting capacity in "Kg"
m - Mass/measurement in "m"

** - Optional { Manuelle Verlängerung
Manual extension

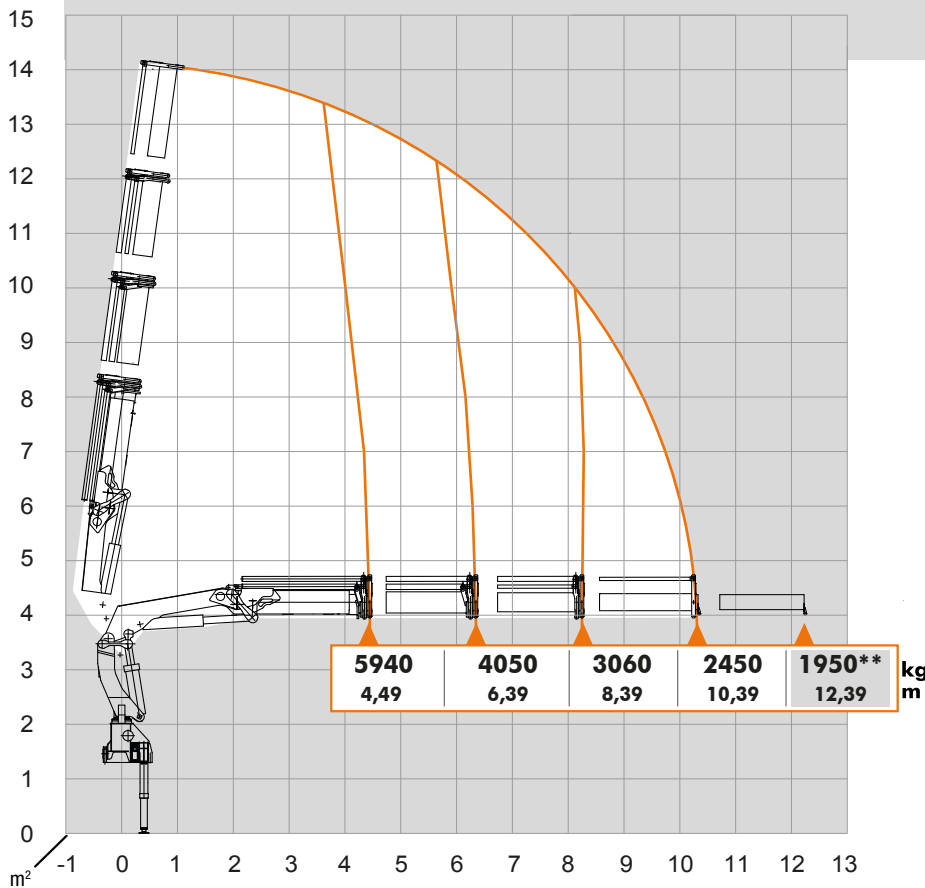

AK 292N A3-10,3/3/V103

Kg - Traglast/lifting capacity in "Kg"
m - Mass/measurement in "m"

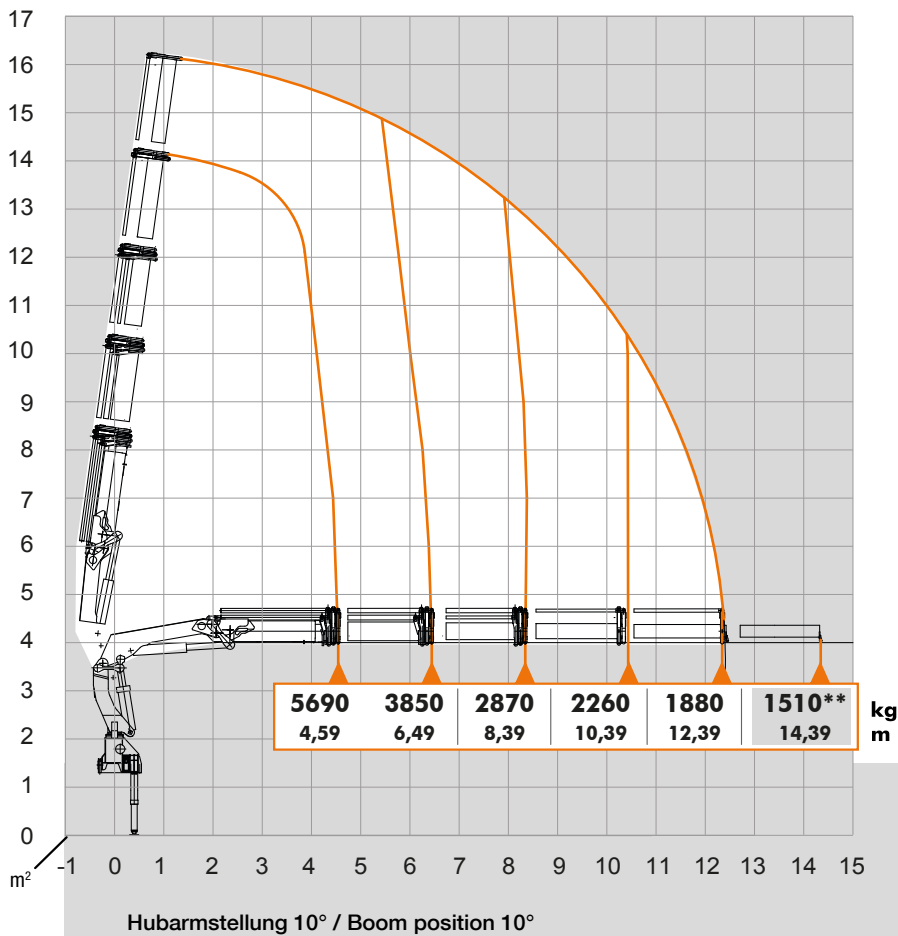

AK 292N A4-12,4/4/V104

Kg - Traglast/lifting capacity in "Kg"
m - Mass/measurement in "m"

** - Optional { Manuelle Verlängerung
Manual extension

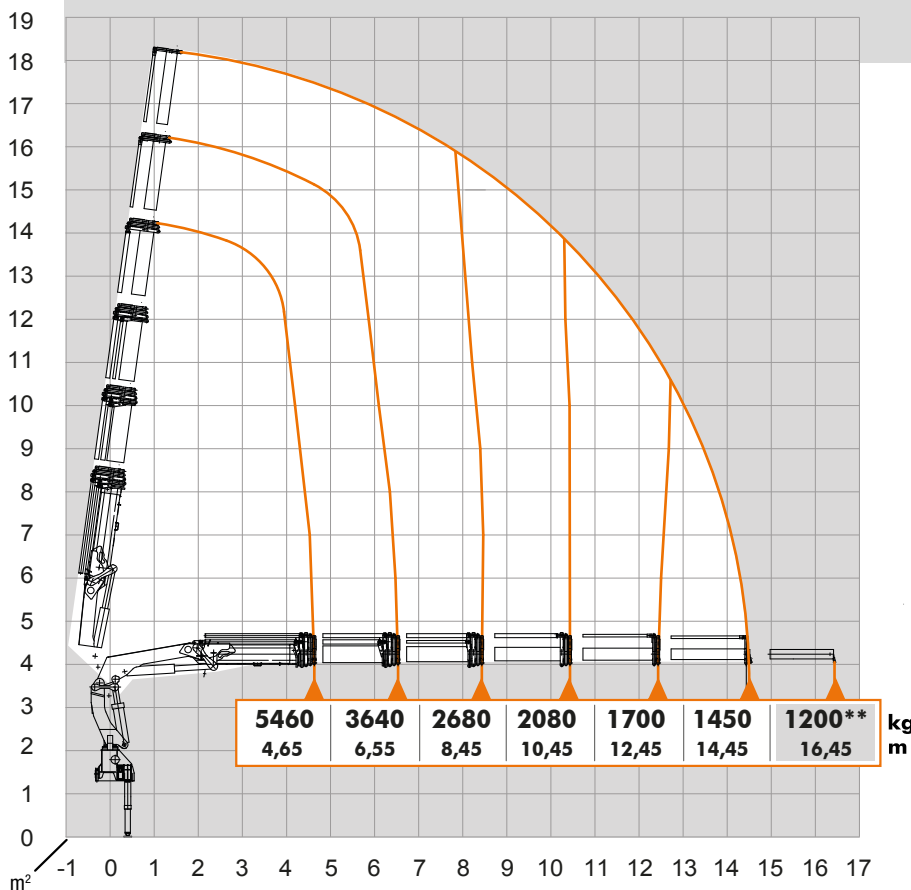

AK 292N A5-14,5/5/V105

Kg - Traglast/lifting capacity in "Kg"
m - Mass/measurement in "m"

AVAILABLE & COST EFFECTIVE

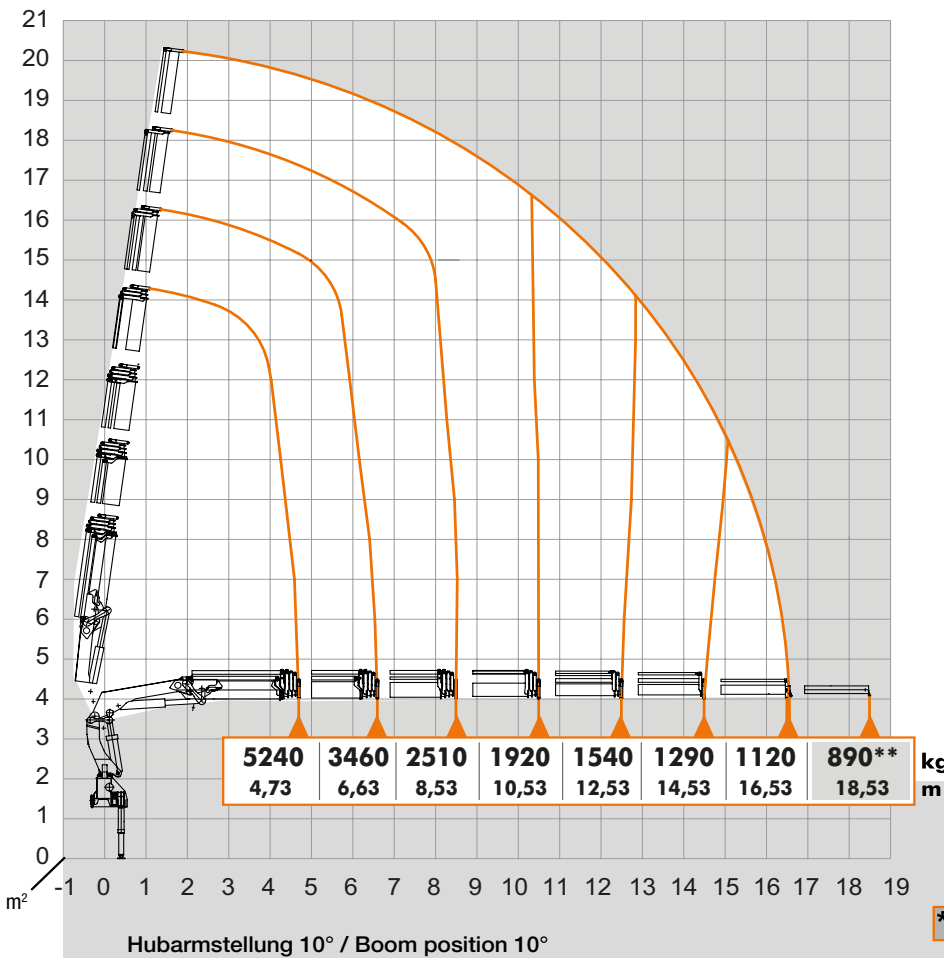

AK 292N A6-16,6/6/V106

Kg - Traglast/lifting capacity in "Kg"
m - Mass/measurement in "m"

** - Optional { Manuelle Verlängerung
Manual extension

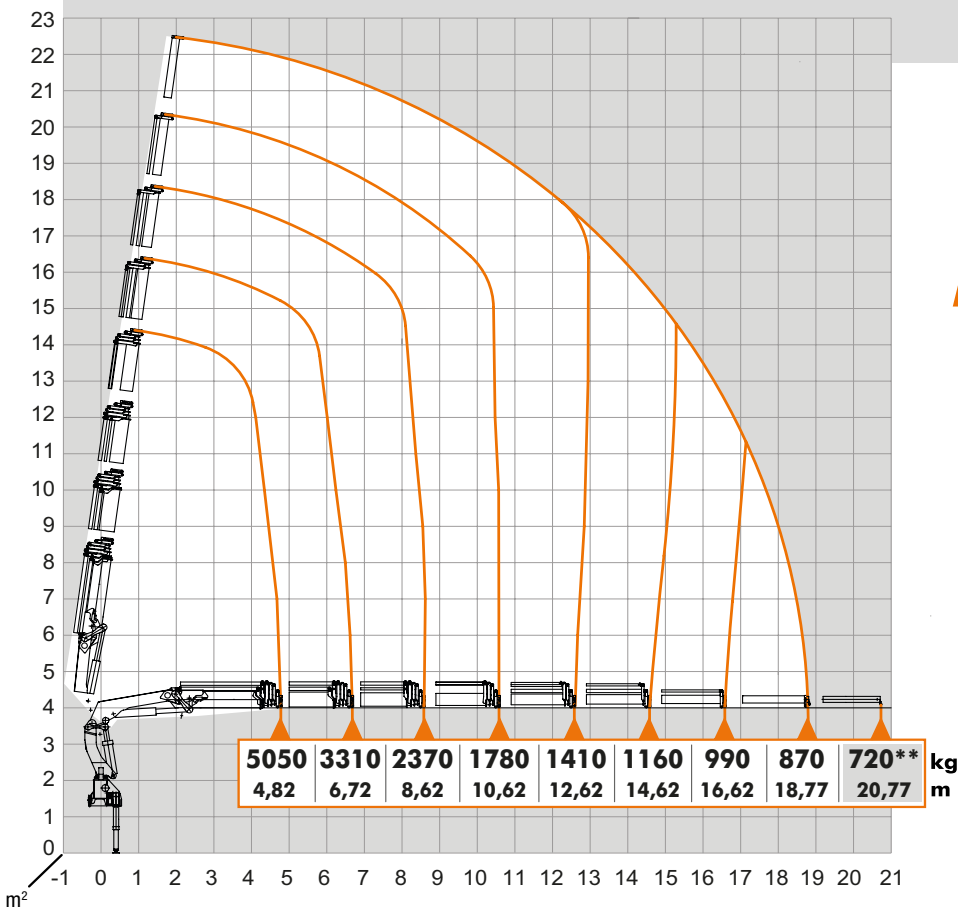

AK 292N A7-18,8/7/V107

Kg - Traglast/lifting capacity in "Kg"
m - Mass/measurement in "m"

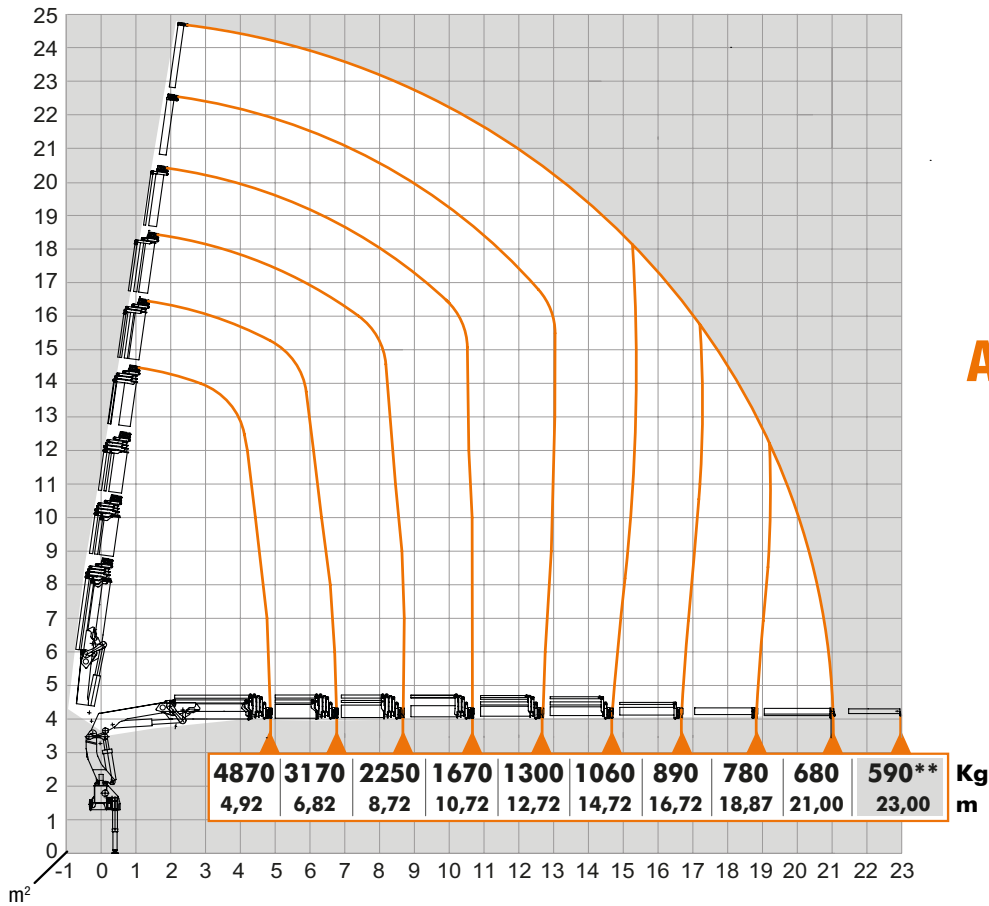

AK 292N A8-21,1/8/V108

Hubarmstellung 10° / Boom position 10°

Kg - Traglast/lifting capacity in "Kg"

m - Mass/measurement in "m"

** - Optional { Manuelle Verlängerung
Manual extension

ABMESSUNGEN / Dimensions

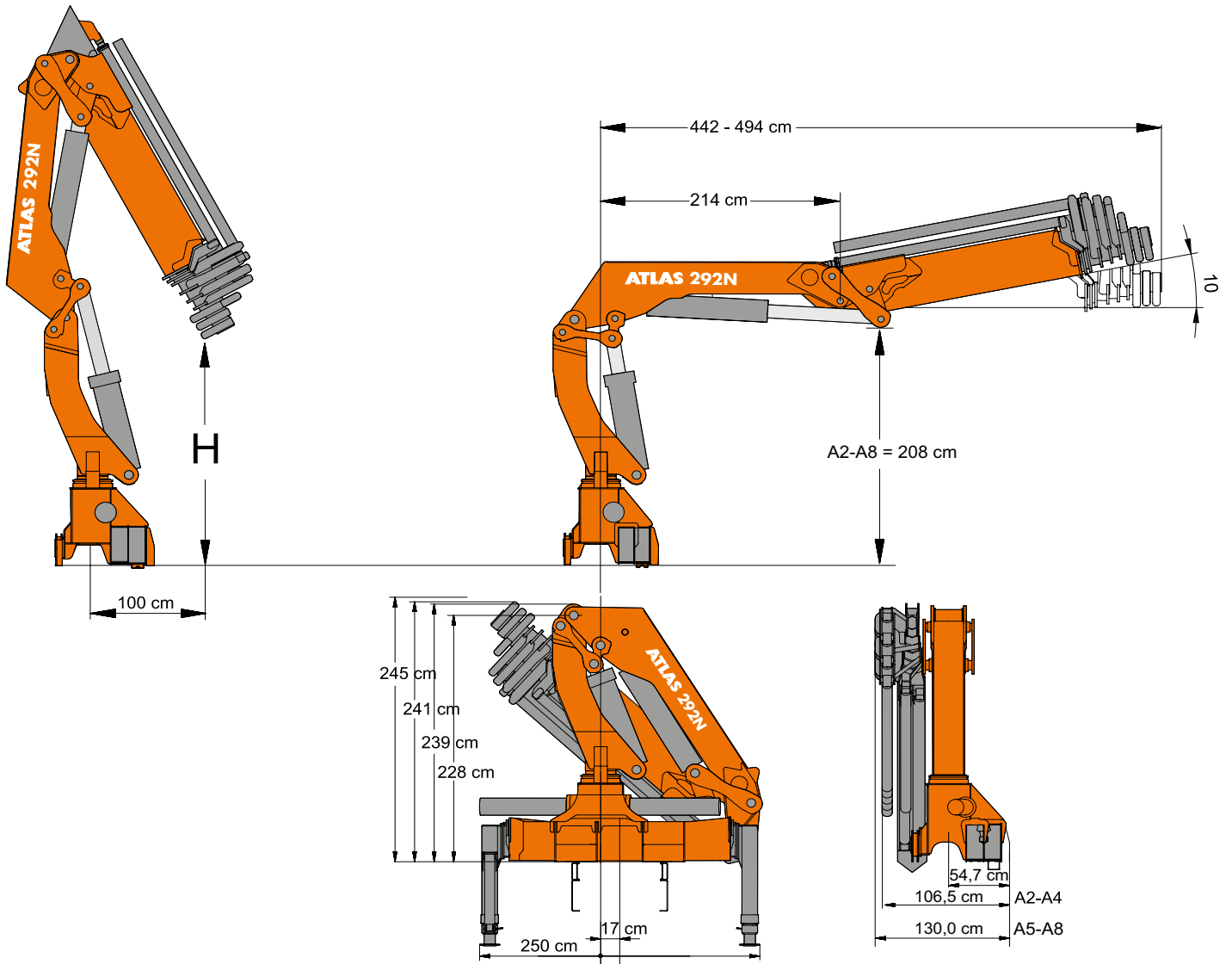

AK 292N

HC1-HD4

Gewicht ohne Abstützungsverbreiterungen und Stützbeine
Weight without stabilizer extensions and stabilizer legs

H

Kranbreite
Crane width









Betriebsdruck
Operating pressure

Ölfördermenge
Oil supply amount

Schwenkbereich
Swivel range

Schwenkmoment
Swivel moment

Hubmoment
Lifting moment

Typ	 Kg	 m	 m	 bar	 l/min	 °	 kNm	 kNm
A 2	2820	2,72	2,50					267,9
A 3	3035	2,61	2,50					261,6
A 4	3235	2,50	2,50					256,2
A 5	3405	2,40	2,50	310	60	410°	35,3	249,1
A 6	3595	2,33	2,50					243,1
A 7	3715	2,24	2,50					238,8
A 8	3825	2,14	2,50					235,1



→ Einfaches Grundgerät im Lasthakenbereich / Simple basic unit for loadhook work

STEUERUNGSMÖGLICHKEITEN / Control options

Funkfernsteuerungen verschaffen dem Bediener ein Höchstmaß an Sicherheit bei der Steuerung von Ladekränen. Aus einer Vielzahl an Ausführungen und Modellen, kann der Bediener, das für sich in Frage kommende Modell auswählen, für ein genaues, feinfühliges und rationelles Arbeiten.

Radio remote control provides the operator with the highest degree of security when controlling the loading crane. In order to guarantee precise, efficient and rational work, the operator can choose from a large number of designs and models.

SCANRECO



- mit 3 Kreuzhebeln
- with 3 cross levers

Optional sind alle Funkfernsteuerungen auch mit Linearhebel und Display erhältlich. Siehe Funkprospekt.

All kinds of wireless link control are also available with a linear lever and a display. See Radio control brochure.

Sitz mit Kreuzhebel und Fußschaltung für Kranbediener, die mit Hand und Fuß arbeiten mögen.

For crane operators willing to work with a hand and a foot, the seat is equipped with a joystick and a foot switch.



Sitz mit Linearsteuerung für Kranbediener, die alles auf Reihe haben wollen.

Seat with linear control for crane operators wanting to have all in a row.



Unterflursteuerung Standardausführung, direkt am Kran.

Underfloor control of a standard design directly at the crane.

AVAILABLE & COST EFFECTIVE

WERK GANDERKESEE GANDERKESEE FACTORY

Atlas GmbH
Atlasstraße 6
D-27777 Ganderkesee,
Germany

Tel.: +49 (0) 4222 954 0
Fax: +49 (0) 4222 954 220
E-mail: info@atlasgmbh.com
www.atlasgmbh.com



WERK VECHTA VECHTA FACTORY

Atlas GmbH
Theodor-Heuss-Str. 3
D-49377 Vechta
Germany

T: +49 (0) 4441 954 0
F: +49 (0) 4441 954 299
E-mail: info@atlasgmbh.com
www.atlasgmbh.com



WERK DELMENHORST DELMENHORST FACTORY

Atlas GmbH
Stedinger Straße 324
D-27751 Delmenhorst
Germany

T: +49 (0) 4221 49 10
F: +49 (0) 4221 49 14 43
E-mail: info@atlasgmbh.com
www.atlasgmbh.com

ATLAS CRANES UK LTD NATIONAL SALES & SERVICE FACILITY

Wharfedale Road,
Euroway Trading Est.
Bradford, England BD4 6SL
United Kingdom

T: +44 8444 99 66 88
F: +44 1274 65 37 85
E-mail: atlasuk@atlasgmbh.com
www.atlas-cranes.co.uk
www.atlasgmbh.com

292N-DE (1) Gültig ab: 05/2018. Produktbeschreibungen und Preise können jederzeit und ohne Verpflichtung zur Ankündigung geändert werden. Die in diesem Dokument enthaltenen Fotos und /oder Zeichnungen dienen rein anschaulichen Zwecken. Anweisungen zur ordnungsgemäßen Verwendung dieser Ausrüstung entnehmen Sie bitte dem zugehörigen Betriebshandbuch. Nichtbefolgung des Betriebshandbuchs bei der Verwendung unserer Produkte oder anderweitig fahrlässiges Verhalten kann zu schwerwiegenden Verletzungen oder Tod führen. Für dieses Produkt wird ausschließlich die entsprechende, schriftlich niedergelegte Standardgarantie gewährt. Atlas leistet keinerlei darüber hinaus gehende Garantie, weder ausdrücklich noch stillschweigend. Die Bezeichnungen der aufgeführten Produkte und Leistungen sind gegebenenfalls Marken, Servicemarken oder Handelsnamen der Atlas GmbH und/oder ihrer Tochtergesellschaften. Alle Rechte vorbehalten. "ATLAS" ist eine eingetragene Marke der Atlas GmbH. Copyright © 2010 Atlas GmbH.

292N-EN (1) Effective date: 05/2018. Product specifications and prices are subject to change without notice or obligation. The photographs and/or drawings in this document are for illustrative purposes only. Refer to the appropriate Operator's Manual for instructions on the proper use of this equipment. Failure to follow the appropriate Operator's Manual when using our equipment or to otherwise act irresponsibly may result in serious injury or death. The only warranty applicable to our equipment is the standard written warranty applicable to the particular product and sale and Atlas makes no other warranty, express or implied. The only warranty applicable to our equipment is the standard written warranty applicable to the particular product and sale and Atlas makes no other warranty, express or implied. Products and services listed may be trademarks, service marks or trade-names of Atlas GmbH and/or its subsidiaries. All rights are reserved. Atlas® is a registered trademark of Atlas GmbH. Copyright © 2010 Atlas GmbH.

Bestell-Nr./ Ref. no.: 6198215-05/18

ATLAS SINCE 1919 **AK 292N**



www.atlasgmbh.com

ATLAS GmbH

CRANES

Atlasstrasse 6

27777 Ganderkesee, Germany

T: +49 (0) 4222 954 0

F: +49 (0) 4222 954 343

info@atlasgmbh.com